

15 Displacements 15 Schluckvolumen 15 Cylindrée 15 Despazamientos	(2.2 – 24.0 in <sup>3</sup> /rev) 36 . . . 390 cm <sup>3</sup> /rev	
Maximum Pressure Eingangsdruck Chaute de pression max. Presion Maxima	Cont (2030 psid) . . .140 bar	Int (2750 psid) . . .190 bar
Maximum Oil Flow Schluckstrom Débit d'huile Caudal Maximo de Aceite	(20 gpm) . . . 75 lpm	
Maximum Speed Drehzahl Vitesse de rotation Velocidad Maxima	(1142 rpm) 1142 rpm	
Maximum Torque Max Drehmoment Couple Maxi Torque Maximo	Cont (4139 lb in) 467 Nm	Int (5728 lb in) 648 Nm
Maximum Side Load at Key Seitenlast Charges latérales Carga Maxima Lateral	(1500 lb) . . . 6650 N	

## An Improved Light Duty Low Speed, High Torque Motor

This light duty motor has higher pressure ratings than the TB motor, for applications requiring higher torque. Robust roller bearings withstand higher side loads and are suitable for chain and sprocket shaft connections. It uses high pressure shaft seals, robust roller bearings and high flow shaft seal cooling.

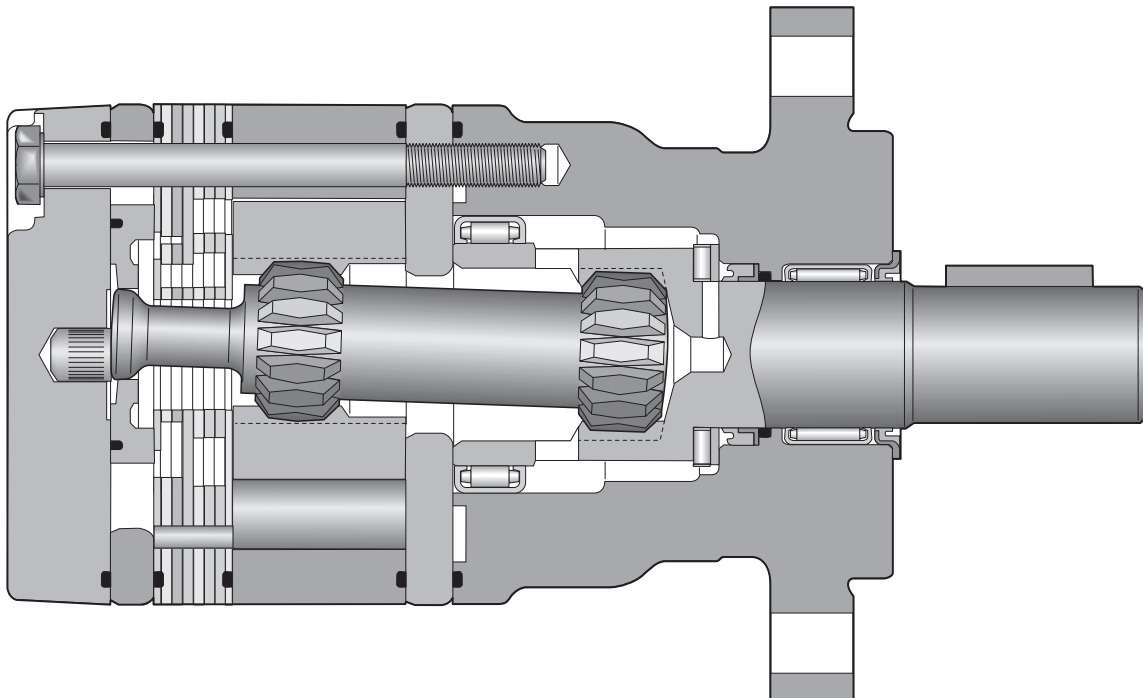
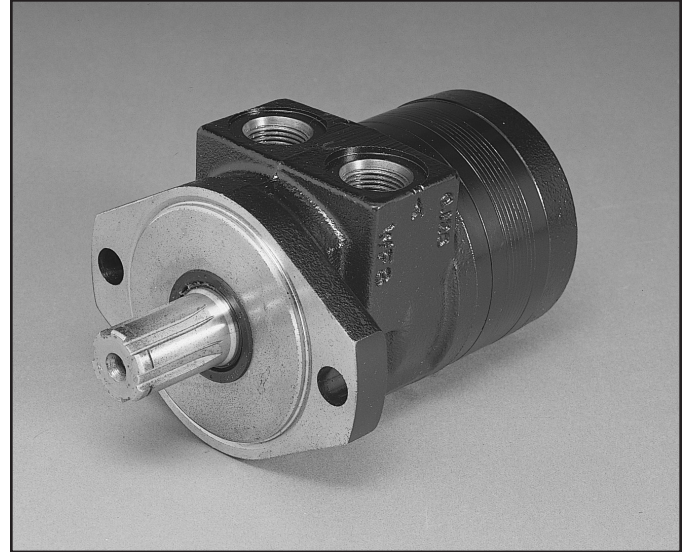

**TE**

Series







**XXXX**



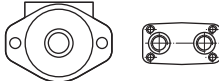

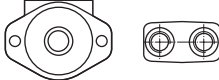

Displacement  
Schluckvolumen  
Cylindrée  
Desplazamiento

Code	cm <sup>3</sup> /U cm <sup>3</sup> /tr cm <sup>3</sup> /giro	in <sup>3</sup> /rev
0036	36 / 2.2	
0045	41 / 2.5	
0050	49 / 3.0	
0065	65 / 4.0	
0080	82 / 5.0	
0100	98 / 6.0	
0130	130 / 8.0	
0165	163 / 10.0	
0195	195 / 11.9	
0230	228 / 13.9	
0260	260 / 15.9	
0295	293 / 17.9	
0330	328 / 20.0	
0365	370 / 22.6	
0390	392 / 24.0	

**XX**

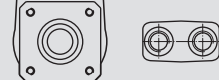
Mounting/Ports  
Gehäuse/Anschluß  
Carter/Plan de raccordement  
Montaje/Lumbreras

Code	Mounting/Ports
AM	SAE "A" 2 Bolt, 5/16-18 UNC Manifold 
AP	SAE "A" 2 Bolt, 1/2-14 NPTF 
AS	SAE "A" 2 Bolt, 7/8-14 SAE 
FP	4 Bolt w/3/8-16 UNC, 1/2-14 NPTF 
FS	4 Bolt w/3/8-16 UNC, 7/8-14 SAE 
US	Wheel Mount, 7/8-14 SAE 







Code	Mounting/Ports
AR	SAE "A" 2 Bolt, Rear Port 3/4-16 SAE O-ring Axial 
CW	SAE "A" 2 Bolt, Long Pilot, G 1/2 BSPP 
FF	4 Bolt w/3/8-16 UNC, 3/4-14 SAE 
FJ	4 Bolt Mt., 9/16 O-ring (SAE # 6) 
JS	"US" w/Mach. Plt. Nose, 1/2 -13UNC C'bored mtg. Holes, 7/8 O-ring ports 
UR	Wheel Mount, Rear Port 3/4-16 SAE O-ring Axial 

Custom Order

Shaded areas indicate custom order components. Standard pricing and delivery terms may not apply to these components. Please refer to the price list for details, or consult your Parker Pump Motor division Sales Resource.



**XX**



Shaft  
Welle  
Arbre  
Eje

Code	Shaft
10	1" Keyed 
11	1" 6B Spline 
13	Long 1" Keyed 
25	1" Tapered 
26	25mm Keyed w/ 8mm Key 
33	1" Tapered, 3/16 Key, 3/4-16 Thd. 

**0**

Rotation  
Drehrichtung  
Direction de rotation  
Rotacion

Code	Rotation
0	Standard 
1	Reverse Timed Manifold 

Code	Rear Port Rotation
0	Standard 
1	Reverse Timed Manifold 

Rotation viewed from shaft end.

**XXXX**

Options  
Opciones

Code	Options
AAAA <sup>8</sup>	"Standard", Black Paint
AAAB	"Standard", No Paint
AAAC <sup>8</sup>	"Standard", Double Paint
AABJ <sup>1,8</sup>	Free Running Rotor Set, Black Paint
AABT <sup>4,8</sup>	No Nut, Black Paint
AAFA	Fluorocarbon Seals, High Temp Commutator Seal, High Temp Section seals, No Paint
AAFW <sup>8</sup>	Fluorocarbon Seals, High Temp Commutator Seal, High Temp Section Seals, Black Paint
AAJH <sup>4,8</sup>	No Shaft Hardware, Fluorocarbon Seals, High Temp Commutator Seal, High Temp Section Seals, Spl paint, Black Paint
AAJL <sup>4</sup>	No Nut, No Paint
AAUP <sup>4</sup>	Fluorocarbon Seals, High Temp Commutator Seal, High Temp Section Seals, No Shaft Hardware, No Paint
AAVE <sup>1,8</sup>	Free Running Rotor Set, Fluorocarbon Seals, High Temp High Temp Section Seals, Commutator Seal, Black Paint
ABCW <sup>4,5,8</sup>	No Shaft Hardware, Fluorocarbon Seals, High Temperature Commutator Seal, High Temp Section Seals, Bidirectional shuttle (.062 Orifice) (11:00"), Black Paint
ABCZ <sup>8</sup>	Fluorocarbon Seals, Double paint, High Temp Commutator Seal, High Temp Section Seals
BBGS <sup>4,5,8</sup>	No Shaft Hardware, Fluorocarbon Seals, High Temperature Commutator Seal, High Temp Section Seals, 921 PSI Int Bidirectional Relief, Black Paint
BBGT <sup>4,5,8</sup>	No Shaft Hardware, Fluorocarbon Seals, High Temperature Commutator Seal, High Temp Section Seals, 1200 PSI Int Bidirectional Relief, Black Paint
BBGU <sup>3,4,5,8</sup>	No Shaft Hardware, Fluorocarbon Seals, High Temperature Commutator Seal, High Temp Section Seals, 2030 PSI Int Bidirectional Relief, Black Paint
BBGW <sup>8</sup>	No Shaft Hardware, Fluorocarbon Seals, High Temperature Commutator Seal, 1450 PSI Int Bidirectional Relief, Black Paint
BBHB <sup>4,5,7,8</sup>	No Shaft Hardware, Fluorocarbon Seals, High Temperature Commutator Seal, 2393 PSI Int Bidirectional Relief, Black Paint
FSEK <sup>4,6,8</sup>	No Shaft Hardware, Fluorocarbon Seals, High Temperature Commutator Seal, High Temp Section Seals, Parker ECD Speed Sensor, Black Paint
FSEN <sup>4,6</sup>	No Shaft Hardware, Fluorocarbon Seals, High Temperature Commutator Seal, High Temp Section Seals, Parker ECD Speed Sensor, No Paint

<sup>1</sup> Not applicable to 0365 & 0390 displacements

<sup>3</sup> Not applicable to 0330, 0365 or 0390 displacements







<sup>4</sup> No Nut with shaft code 12, 25 or 33

<sup>5</sup> Not applicable with FR or AR Mounting / Porting options

<sup>6</sup> Not applicable with shaft code 33

<sup>7</sup> Not applicable to 0260, 0295, 0330, 0365 or 0390 displacements

<sup>8</sup> Paint area all over except front and rear pilot and mounting flanges and shaft

Code	Shaft
01	Long 6B Spline, Groove 
09	1" dia., 0.38" Hole, 0.55" From End 
12	Short 1" Tapered 
21	1" Keyed Corrosion Resistant 
22	25mm Str. w/7mm Key, 6mm Tap 
41	Long 6B, 8mm Tap 

\* Conforms to SAE B recommended length

Shaded areas indicate custom order components. Standard pricing and delivery terms may not apply to these components. Please refer to the price list for details, or consult your Parker Pump Motor division Sales Resource.

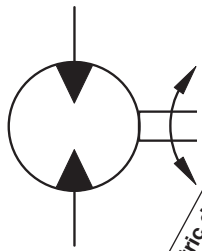

Geometric displacement  
Geom. Schluckvolumen  
Cylindrée  
Desplazamientos  
Max. speed @ Max. intermittent flow  
Max. Drehzahl Intermittierender Betrieb:  
Velocidad de rotación maxi  
Max. oil flow  
Max. Schluckstrom  
Caudal Máximo de Aceite  
Max. Differential Pressure  
Max. Druckgefälle  
Chute de pression maxi  
Presion diferencial maxima  
Max. supply pressure  
Max. Eingangsdruck  
Presion maxi entrée  
Max. torque  
Max. Drehmoment  
Couple maxi  
Torque Maximo  
Max. performance  
Max. Leistungabgabe  
Maximo rendimiento  
Min. starting torque  
Min. Anlaufmoment  
Couple min. fourni au démarrage  
Torque minimo de arranque

Motor Series TE	cm <sup>3</sup> /rev in <sup>3</sup> /rev	Int rev/min	cont / int* l/min g/min		cont / int* bar psid		max bar psig	cont / int* Nm lb-in		max KW HP	cont / int* Nm lb-in	
TE 0036	36 2.2	1141	34 9	42 11	140 2030	190 2750	200 2900	54.6 483	71.1 630	8.5 11.4	44 389	52 460
TE 0045	41 2.5	1024	34 9	42 11	140 2030	190 2750	200 2900	71 624	99 876	10.4 13.9	44 411	64 565
TE 0050	49 3.0	1020	34 9	50 13	140 2030	190 2750	200 2900	90 796	127 1120	12.8 17.2	72 637	98 871
TE 0065	65 4.0	877	45 12	57 15	140 2030	190 2750	200 2900	125 1106	176 1558	14.7 19.8	100 885	137 1211
TE 0080	82 5.0	695	45 12	57 15	140 2030	190 2750	200 2900	160 1416	220 1947	17.3 23.2	128 1133	171 1515
TE 0100	98 6.0	582	45 12	57 15	140 2030	190 2750	200 2900	190 1682	264 2337	17.4 23.4	152 1345	205 1819
TE 0130	130 8.0	438	45 12	57 15	140 2030	190 2750	200 2900	255 2257	352 3116	17.3 23.2	204 1806	274 2423
TE 0165	163 10.0	348	45 12	57 15	140 2030	190 2750	200 2900	310 2744	436 3846	17.0 22.8	248 2195	338 2992
TE 0195	195 11.9	292	45 12	57 15	140 2030	190 2750	200 2900	390 3452	528 4673	17.4 23.4	312 2762	411 3637
TE 0230	228 13.9	328	57 15	75 20	120 1740	165 2400	200 2900	380 3363	514 4554	17.7 23.8	304 2691	411 3637
TE 0260	260 15.9	287	57 15	75 20	110 1595	155 2250	200 2900	400 3540	550 4870	16.7 22.4	320 2832	449 3977
TE 0295	293 17.9	256	57 15	75 20	100 1450	145 2100	200 2900	428 3784	582 5180	15.7 21.0	328 2903	445 3939
TE 0330	328 20.0	228	57 15	75 20	100 1450	135 1950	200 2900	443 3926	600 5312	14.8 19.8	344 3045	453 4014
TE 0365	370 22.6	203	57 15	75 20	95 1378	125 1825	200 2900	467 4133	648 5728	13.6 18.2	373 3301	477 4223
TE 0390	392 24.0	191	57 15	75 20	85 1233	120 1740	200 2900	445 3935	628 5562	12.5 16.8	348 3080	462 4090

Performance data based on testing using 10W40 oil with a viscosity of 43,1 cSt. (200 SUS) at 54° C (130° F). Performance data is typical. Actual data may vary slightly from one production motor to another.

Les données sur les performances sont basées sur des tests utilisant de l'huile 10W40 d'une viscosité de 200 SUS à 54°C (130°F). Ces données correspondent à des situations typiques. Les données réelles peuvent varier légèrement d'un moteur de production à l'autre.

Leistungsdaten sind gemessen mit SAE 10W40 bei einer Viskosität von 43,1 Cst bei 54°C. Geringfügige Abweichungen von den Katalogdaten sind möglich.

Datos tecnicos obtenidos con aceite 10W40 de 200 SUS de viscosidad a 54°C (130°F). Los datos proporcionados son valores típicos. Los valores exactos reales podrían tener una pequeña variación entre distintos motores.

\* Intermittent operation rating applies to 10% of every minute.  
Intermittierende Werte maximal 10% von jeder Betriebsminute.  
Fonctionnement interm. 10% max. de chaque minute d'utilisation.  
Capacidad de funcionamiento intermitente valida para 10% por cada minuto.



TE 0036 **2.2 cu in / rev** PRESSURE (PSID)

	500	1000	1500	2000	2750
<b>.5</b>	111	225	346	470	
	<b>44</b>	<b>37</b>	<b>25</b>	<b>15</b>	
<b>1</b>	113	231	353	480	670
	<b>96</b>	<b>86</b>	<b>77</b>	<b>67</b>	<b>40</b>
<b>2</b>	115	239	365	495	691
	<b>202</b>	<b>190</b>	<b>179</b>	<b>169</b>	<b>140</b>
<b>3</b>	113	241	371	505	709
	<b>307</b>	<b>296</b>	<b>282</b>	<b>269</b>	<b>240</b>
<b>4</b>	109	241	373	509	722
	<b>411</b>	<b>397</b>	<b>384</b>	<b>371</b>	<b>340</b>
<b>5</b>	103	237	371	509	726
	<b>516</b>	<b>501</b>	<b>486</b>	<b>470</b>	<b>440</b>
<b>7</b>	87	225	361	501	711
	<b>724</b>	<b>709</b>	<b>691</b>	<b>674</b>	<b>641</b>
<b>9</b>	72	208	344	482	672
	<b>933</b>	<b>916</b>	<b>897</b>	<b>877</b>	<b>841</b>
<b>11</b>	54	190	326	462	629
	<b>1142</b>	<b>1117</b>	<b>1096</b>	<b>1075</b>	<b>1045</b>

Flow (GPM)

TORQUE (LB IN) 711  
SPEED (RPM) 641

TE 0045 **2.5 cu in / rev** PRESSURE (PSID)

	500	1000	1500	2000	2750
<b>.5</b>	121	272	425	579	808
	<b>41</b>	<b>35</b>	<b>28</b>	<b>22</b>	<b>10</b>
<b>1</b>	126	282	440	599	832
	<b>86</b>	<b>79</b>	<b>72</b>	<b>65</b>	<b>50</b>
<b>2</b>	128	288	452	619	867
	<b>176</b>	<b>168</b>	<b>161</b>	<b>152</b>	<b>134</b>
<b>3</b>	126	287	453	620	868
	<b>266</b>	<b>257</b>	<b>249</b>	<b>239</b>	<b>221</b>
<b>4</b>	123	285	454	624	876
	<b>356</b>	<b>346</b>	<b>337</b>	<b>326</b>	<b>306</b>
<b>5</b>	119	281	451	624	877
	<b>446</b>	<b>435</b>	<b>425</b>	<b>413</b>	<b>391</b>
<b>7</b>	105	270	440	615	872
	<b>625</b>	<b>613</b>	<b>601</b>	<b>587</b>	<b>562</b>
<b>9</b>	94	259	430	605	862
	<b>805</b>	<b>791</b>	<b>777</b>	<b>761</b>	<b>733</b>
<b>11</b>	81	246	415	590	849
	<b>983</b>	<b>967</b>	<b>950</b>	<b>930</b>	<b>896</b>

Flow (GPM)

TORQUE (LB IN) 872  
SPEED (RPM) 562

Cont.  Int.

Intermittent operation rating applies to 10% of every minute.  
Fonctionnement interm. 10% max. de chaque minute d'utilisation.

Performance data based on testing using 10W40 oil with a viscosity of 200 SUS at 54° C (130° F). Performance data is typical. Actual data may vary slightly from one production motor to another.

Les donnees sur les performances sont basees sur des tests utilisant de l'huile 10W40 d'une viscosite de 200 SUS a 54°C (130°F). Ces donnees correspondent a des situations typiques. Les donnees reelles peuvent varier legerement d'un moteur de production a l'autre.

Intermittierende Werte maximal 10% von jeder Betriebsminute.  
Capacidad de funcionamiento intermitente valida para 6 segundos por cada minuto.

Leistungsdaten sind gemessen mit SAE 10W40 bei einer Viskosität von 43,1 Cst bei 54°C. Geringfügige Abweichungen von den Katalogdaten sind möglich.

Datos tecnicos obtenidos con aceite 10W40 de 200 SUS de viscosidad a 54°C (130°F). Los datos proporcionados son valores tipicos. Los valores exactos reales podrian tener una pequena variacion entre distintos motores.

TE 0050 **3.0** cu in / rev PRESSURE (PSID)

	500	1000	1500	2000	2750
<b>.5</b>	146 32	327 23	513 13	705 6	
<b>1</b>	159 69	345 60	537 50	727 41	1005 17
<b>2</b>	170 145	364 136	563 124	764 113	1057 85
<b>3</b>	167 225	363 214	565 203	768 191	1066 163
<b>4</b>	169 294	367 282	574 271	784 260	1092 231
<b>5</b>	165 363	365 349	574 339	785 327	1097 297
<b>7</b>	156 501	357 485	568 474	782 460	1096 430
<b>9</b>	141 640	342 621	555 609	771 594	1087 561
<b>13</b>	88 904	295 881	503 869	722 851	1036 819

Flow (GPM)



TE 0065 **4.0** cu in / rev PRESSURE (PSID)

	500	1000	1500	2000	2750
<b>.5</b>	220 24	481 17	743 11	1004 3	
<b>1</b>	232 52	498 45	763 38	1025 31	1411 19
<b>2</b>	239 109	512 102	789 94	1066 85	1469 65
<b>3</b>	238 167	512 159	790 151	1068 141	1474 120
<b>4</b>	237 224	514 215	795 207	1078 197	1492 179
<b>5</b>	233 279	511 271	794 262	1080 252	1502 234
<b>7</b>	216 386	497 376	783 366	1072 356	1497 336
<b>9</b>	195 494	477 483	764 472	1054 460	1481 439
<b>12</b>	152 654	435 641	724 629	1017 617	1445 596
<b>15</b>	102 802	388 789	676 776	969 763	1391 740

Flow (GPM)



Cont.  Int.

Intermittent operation rating applies to 10% of every minute.  
Fonctionnement interm. 10% max. de chaque minute d'utilisation.

Performance data based on testing using 10W40 oil with a viscosity of 200 SUS at 54° C (130° F). Performance data is typical. Actual data may vary slightly from one production motor to another.

Les donnees sur les performances sont basees sur des tests utilisant de l'huile 10W40 d'une viscosite de 200 SUS a 54°C (130°F). Ces donnees correspondent a des situations typiques. Les donnees reelles peuvent varier legerement d'un moteur de production a l'autre.

Intermittierende Werte maximal 10% von jeder Betriebsminute.

Capacidad de funcionamiento intermitente valida para 6 segundos por cada minuto.

Leistungsdaten sind gemessen mit SAE 10W40 bei einer Viskosität von 43,1 Cst bei 54°C. Geringfügige Abweichungen von den Katalogdaten sind möglich.

Datos tecnicos obtenidos con aceite 10W40 de 200 SUS de viscosidad a 54°C (130°F). Los datos proporcionados son valores tipicos. Los valores exactos reales podrian tener una pequena variacion entre distintos motores.

TE 0080 **5.0** cu in / rev PRESSURE (PSID)

	500	1000	1500	2000	2750
<b>.5</b>	261 17	575 8			
<b>1</b>	276 39	596 30	918 23	1245 13	
<b>2</b>	290 85	631 76	974 68	1310 56	1784 35
<b>3</b>	291 131	633 122	978 113	1319 101	1819 79
<b>4</b>	293 177	642 167	995 158	1347 146	1854 121
<b>5</b>	290 223	641 213	999 203	1359 191	1884 165
<b>7</b>	273 316	628 304	989 293	1353 280	1890 253
<b>9</b>	249 408	603 396	966 384	1334 370	1873 340
<b>12</b>	197 546	551 533	916 519	1287 504	1827 472
<b>15</b>	136 686	494 670	857 655	1226 638	1762 603

TORQUE (LB IN) 1890  
SPEED (RPM) 253

Flow (GPM)

TE 0100 **6.0** cu in / rev PRESSURE (PSID)

	500	1000	1500	2000	2750
<b>.5</b>	315 14	687 7			
<b>1</b>	332 33	710 26	1083 18	1460 9	
<b>2</b>	348 71	751 64	1152 55	1541 45	2089 27
<b>3</b>	350 109	756 102	1160 92	1556 83	2138 62
<b>4</b>	353 147	768 140	1185 130	1596 120	2189 99
<b>5</b>	349 186	771 178	1197 168	1622 158	2235 137
<b>7</b>	330 263	759 254	1191 244	1624 232	2258 209
<b>9</b>	302 340	731 330	1167 319	1606 307	2246 284
<b>12</b>	243 456	671 444	1111 433	1555 420	2198 394
<b>15</b>	176 572	606 558	1042 546	1484 533	2121 505

TORQUE (LB IN) 2258  
SPEED (RPM) 209

Flow (GPM)

Cont.  Int.

Intermittent operation rating applies to 10% of every minute.  
Fonctionnement interm. 10% max. de chaque minute d'utilisation.

Performance data based on testing using 10W40 oil with a viscosity of 200 SUS at 54° C (130° F). Performance data is typical. Actual data may vary slightly from one production motor to another.

Les donnees sur les performances sont basees sur des tests utilisant de l'huile 10W40 d'une viscosite de 200 SUS a 54°C (130°F). Ces donnees correspondent a des situations typiques. Les donnees reelles peuvent varier legerement d'un moteur de production a l'autre.

Intermittierende Werte maximal 10% von jeder Betriebsminute.  
Capacidad de funcionamiento intermitente valida para 6 segundos por cada minuto.

Leistungsdaten sind gemessen mit SAE 10W40 bei einer Viskosität von 43,1 Cst bei 54°C. Geringfügige Abweichungen von den Katalogdaten sind möglich.

Datos tecnicos obtenidos con aceite 10W40 de 200 SUS de viscosidad a 54°C (130°F). Los datos proporcionados son valores tipicos. Los valores exactos reales podrian tener una pequena variacion entre distintos motores.



TE 0130 **8.0** cu in / rev PRESSURE (PSID)

	500	1000	1500	2000	2750
<b>.5</b>	445 12	962 10	1488 7	2018 3	
<b>1</b>	464 27	996 24	1525 21	2051 17	2835 5
<b>2</b>	482 55	1032 53	1584 49	2136 44	2940 31
<b>3</b>	483 84	1037 81	1594 77	2150 72	2961 60
<b>4</b>	483 113	1051 110	1619 105	2184 100	3015 87
<b>5</b>	478 142	1050 138	1625 133	2201 128	3050 114
<b>7</b>	450 200	1029 195	1613 190	2195 183	3054 169
<b>9</b>	414 257	993 252	1579 247	2166 239	3030 224
<b>12</b>	338 344	915 338	1503 331	2096 323	2961 306
<b>15</b>	252 431	827 424	1408 416	1996 407	2851 389

TORQUE (LB IN) 3054  
SPEED (RPM) 169

Flow (GPM)

TE 0165 **10.0** cu in / rev PRESSURE (PSID)

	500	1000	1500	2000	2750
<b>.5</b>	552 9	1175 7	1813 4	2457 3	
<b>1</b>	574 21	1213 18	1856 16	2499 12	3465 7
<b>2</b>	597 44	1263 41	1938 38	2614 33	3604 25
<b>3</b>	600 67	1273 64	1955 60	2634 55	3628 46
<b>4</b>	603 90	1299 87	1997 83	2691 78	3705 67
<b>5</b>	597 113	1302 109	2015 105	2727 100	3767 89
<b>7</b>	569 159	1286 155	2009 150	2732 144	3791 133
<b>9</b>	523 205	1244 201	1976 195	2707 189	3773 177
<b>12</b>	429 274	1152 269	1890 263	2630 256	3701 242
<b>15</b>	316 344	1039 338	1769 331	2500 323	3568 308

TORQUE (LB IN) 3791  
SPEED (RPM) 133

Flow (GPM)

Cont.  Int.

Intermittent operation rating applies to 10% of every minute.  
Fonctionnement interm. 10% max. de chaque minute d'utilisation.

Performance data based on testing using 10W40 oil with a viscosity of 200 SUS at 54° C (130° F). Performance data is typical. Actual data may vary slightly from one production motor to another.

Les donnees sur les performances sont basees sur des tests utilisant de l'huile 10W40 d'une viscosite de 200 SUS a 54°C (130°F). Ces donnees correspondent a des situations typiques. Les donnees reelles peuvent varier legerement d'un moteur de production a l'autre.

Intermittierende Werte maximal 10% von jeder Betriebsminute.  
Capacidad de funcionamiento intermitente valida para 6 segundos por cada minuto.

Leistungsdaten sind gemessen mit SAE 10W40 bei einer Viskosität von 43,1 Cst bei 54°C. Geringfügige Abweichungen von den Katalogdaten sind möglich.

Datos tecnicos obtenidos con aceite 10W40 de 200 SUS de viscosidad a 54°C (130°F). Los datos proporcionados son valores tipicos. Los valores exactos reales podrian tener una pequena variacion entre distintos motores.



TE 0195 **11.9** cu in / rev PRESSURE (PSID)

	500	1000	1500	2000	2750
<b>.5</b>	710 8	1519 7	2344 5	3182 3	
<b>1</b>	736 18	1558 16	2387 14	3221 12	4457 6
<b>2</b>	758 37	1596 35	2445 33	3302 30	4558 22
<b>3</b>	758 56	1604 54	2459 51	3315 48	4576 39
<b>4</b>	757 75	1618 73	2482 70	3346 67	4619 56
<b>5</b>	747 95	1615 92	2488 89	3360 85	4643 74
<b>7</b>	705 133	1586 130	2467 127	3343 122	4631 111
<b>9</b>	646 172	1528 169	2415 165	3300 160	4590 147
<b>12</b>	530 230	1408 226	2303 221	3197 215	4494 201
<b>15</b>	394 288	1273 283	2147 278	3027 272	4308 256

TORQUE (LB IN) 4631  
SPEED (RPM) 111

Flow (GPM)

TE 0230 **13.9** cu in / rev PRESSURE (PSID)

	500	1000	1500	1750	2000	2400
<b>.5</b>	761 7	1673 6	2614 5	3094 4	3584 3	4331 3
<b>1</b>	791 15	1712 14	2650 13	3128 12	3615 11	4366 9
<b>2</b>	819 32	1764 30	2726 29	3208 28	3692 26	4448 24
<b>3</b>	819 48	1771 47	2737 45	3226 44	3718 42	4482 41
<b>4</b>	821 65	1787 63	2765 61	3256 60	3750 58	4520 56
<b>5</b>	808 81	1786 79	2777 77	3277 76	3778 74	4554 73
<b>7</b>	770 114	1756 112	2755 109	3255 108	3760 106	4535 104
<b>9</b>	705 147	1699 145	2710 142	3216 140	3724 138	4496 137
<b>12</b>	581 197	1582 194	2595 191	3103 189	3617 186	4382 183
<b>15</b>	400 247	1409 243	2437 239	2949 237	3466 235	4216 230
<b>20</b>	64 329	1052 325	2067 321	2580 319	3100 316	3814 311

TORQUE (LB IN) 1894  
SPEED (RPM) 198

Flow (GPM)

Cont.  Int.

Intermittent operation rating applies to 10% of every minute.  
Fonctionnement interm. 10% max. de chaque minute d'utilisation.

Intermittierende Werte maximal 10% von jeder Betriebsminute.  
Capacidad de funcionamiento intermitente valida para 6 segundos por cada minuto.

Performance data based on testing using 10W40 oil with a viscosity of 200 SUS at 54° C (130° F). Performance data is typical. Actual data may vary slightly from one production motor to another.

Leistungsdaten sind gemessen mit SAE 10W40 bei einer Viskosität von 43,1 Cst bei 54°C. Geringfügige Abweichungen von den Katalogdaten sind möglich.

Les données sur les performances sont basées sur des tests utilisant de l'huile 10W40 d'une viscosité de 200 SUS à 54°C (130°F). Ces données correspondent à des situations typiques. Les données réelles peuvent varier légèrement d'un moteur de production à l'autre.

Datos tecnicos obtenidos con aceite 10W40 de 200 SUS de viscosidad a 54°C (130°F). Los datos proporcionados son valores típicos. Los valores exactos reales podrían tener una pequeña variación entre distintos motores.



TE 0260 **15.9** cu in / rev PRESSURE (PSID)

	500	1000	1500	1650	2250
<b>.5</b>	908 7	1961 6	3048 6	3380 6	4631 5
<b>1</b>	938 14	2006 13	3099 13	3433 12	4692 11
<b>2</b>	971 28	2059 27	3165 26	3501 26	4779 23
<b>3</b>	968 43	2065 42	3177 40	3514 39	4797 38
<b>4</b>	970 57	2081 56	3203 54	3541 53	4837 50
<b>5</b>	957 71	2084 70	3219 68	3561 67	4870 64
<b>7</b>	907 100	2049 98	3198 96	3542 95	4856 91
<b>9</b>	837 129	1985 127	3143 124	3489 123	4799 117
<b>12</b>	692 172	1844 169	3016 166	3367 164	4671 157
<b>15</b>	489 215	1647 212	2830 208	3188 206	4494 200
<b>20</b>	129 287	1255 283	2418 279	2773 277	4031 270

TORQUE (LB IN) 4856  
SPEED (RPM) 91

TE 0295 **17.9** cu in / rev PRESSURE (PSID)

	500	1000	1500	1550	2100
<b>.5</b>	1014 6	2216 5	3453 4	3576 4	4900 3
<b>1</b>	1051 12	2270 11	3509 10	3633 10	4963 8
<b>2</b>	1088 25	2334 24	3600 22	3727 22	5092 21
<b>3</b>	1085 38	2338 36	3611 35	3739 34	5110 33
<b>4</b>	1085 50	2353 49	3639 47	3769 47	5152 44
<b>5</b>	1072 63	2352 62	3654 60	3784 59	5180 57
<b>7</b>	1019 89	2311 87	3624 85	3755 84	5159 80
<b>9</b>	939 115	2237 113	3561 110	3693 110	5098 104
<b>12</b>	776 153	2074 151	3403 148	3537 147	4931 142
<b>15</b>	545 192	1853 189	3184 186	3319 185	4689 180
<b>20</b>	126 256	1408 253	2697 249	2826 249	4099 243

TORQUE (LB IN) 5159  
SPEED (RPM) 80

Flow (GPM)

Cont.  Int.

Intermittent operation rating applies to 10% of every minute.  
Fonctionnement interm. 10% max. de chaque minute d'utilisation.

Performance data based on testing using 10W40 oil with a viscosity of 200 SUS at 54° C (130° F). Performance data is typical. Actual data may vary slightly from one production motor to another.

Les donnees sur les performances sont basees sur des tests utilisant de l'huile 10W40 d'une viscosite de 200 SUS a 54°C (130°F). Ces donnees correspondent a des situations typiques. Les donnees reelles peuvent varier legerement d'un moteur de production a l'autre.

Intermittierende Werte maximal 10% von jeder Betriebsminute.

Capacidad de funcionamiento intermitente valida para 6 segundos por cada minuto.

Leistungsdaten sind gemessen mit SAE 10W40 bei einer Viskosität von 43,1 Cst bei 54°C. Geringfügige Abweichungen von den Katalogdaten sind möglich.

Datos tecnicos obtenidos con aceite 10W40 de 200 SUS de viscosidad a 54°C (130°F). Los datos proporcionados son valores tipicos. Los valores exactos reales podrian tener una pequena variacion entre distintos motores.

TE 0330 **20.0** cu in / rev PRESSURE (PSID)

	500	1000	1500	1950
<b>.5</b>	1184 5	2507 5	3722 4	5040 3
<b>1</b>	1218 11	2558 10	3772 9	5093 8
<b>2</b>	1258 22	2632 21	3867 20	5224 19
<b>3</b>	1251 34	2633 32	3879 31	5242 30
<b>4</b>	1249 45	2649 44	3909 42	5287 40
<b>5</b>	1229 57	2648 55	3926 53	5312 50
<b>7</b>	1162 80	2600 78	3898 75	5296 71
<b>9</b>	1064 103	2518 100	3829 98	5219 93
<b>12</b>	875 137	2333 135	3657 131	5026 127
<b>15</b>	621 171	2081 169	3420 165	4770 160
<b>20</b>	163 229	1576 226	2875 222	4129 214

TORQUE (LB IN) 5219  
SPEED (RPM) 93

TE 0365 **22.6** cu in / rev PRESSURE (PSID)

	500	1000	1325	1825
<b>.5</b>	1393 5	2942 4	3974 4	5539 3
<b>1</b>	1444 10	3005 9	4036 8	5599 7
<b>2</b>	1494 20	3090 19	4131 18	5714 17
<b>3</b>	1485 30	3082 29	4125 28	5709 27
<b>4</b>	1477 40	3089 39	4139 37	5728 36
<b>5</b>	1452 50	3075 49	4130 47	5719 45
<b>7</b>	1371 70	3009 69	4071 67	5654 63
<b>9</b>	1260 90	2899 89	3669 87	5543 84
<b>12</b>	1002 121	2658 119	3737 117	5283 113
<b>15</b>	700 151	2355 149	3432 146	4937 142
<b>20</b>	152 201	1776 199	2838 196	4228 191

TORQUE (LB IN) 5543  
SPEED (RPM) 84

Flow (GPM)

Cont.  Int.

Intermittent operation rating applies to 10% of every minute.  
Fonctionnement interm. 10% max. de chaque minute d'utilisation.  
Performance data based on testing using 10W40 oil with a viscosity of 200 SUS at 54° C (130° F). Performance data is typical. Actual data may vary slightly from one production motor to another.  
Les donnees sur les performances sont basees sur des tests utilisant de l'huile 10W40 d'une viscosite de 200 SUS a 54°C (130°F). Ces donnees correspondent a des situations typiques. Les donnees reelles peuvent varier legerement d'un moteur de production a l'autre.

Intermittierende Werte maximal 10% von jeder Betriebsminute.  
Capacidad de funcionamiento intermitente valida para 6 segundos por cada minuto.  
Leistungsdaten sind gemessen mit SAE 10W40 bei einer Viskositat von 43,1 Cst bei 54°C. Geringfuegige Abweichungen von den Katalogdaten sind moeglich.  
Datos tecnicos obtenidos con aceite 10W40 de 200 SUS de viscosidad a 54°C (130°F). Los datos proporcionados son valores tipicos. Los valores exactos reales podrian tener una pequena variacion entre distintos motores.

004 TE.indd, b



**WARNING**  
This product can expose you to chemicals including lead and DEHP, which are known to the State of California to cause cancer, and birth defects or other reproductive harm. For more information go to www.p65warnings.ca.gov

TE 0390 **24.0** cu in / rev PRESSURE (PSID)

	500	1000	1250	1750
<b>.5</b>	1326 4	2889 3	3682 2	5244 2
<b>1</b>	1380 9	2934 7	3724 7	5283 6
<b>2</b>	1443 18	3034 17	3840 15	5427 13
<b>3</b>	1442 28	3049 26	3861 25	5458 22
<b>4</b>	1454 37	3084 36	3905 34	5518 32
<b>5</b>	1447 47	3104 45	3935 44	5562 40
<b>7</b>	1393 66	3080 64	3923 62	5559 60
<b>9</b>	1297 85	3013 83	3868 81	5507 79
<b>12</b>	1088 114	2818 112	3686 110	5308 106
<b>15</b>	797 143	2539 140	3414 138	5002 135
<b>20</b>	264 191	2006 188	2880 186	4374 182

TORQUE (LB IN) 5559  
SPEED (RPM) 60

**Flow (GPM)**

Cont.  Int.

Intermittent operation rating applies to 10% of every minute.  
Fonctionnement interm. 10% max. de chaque minute d'utilisation.

Performance data based on testing using 10W40 oil with a viscosity of 200 SUS at 54° C (130° F). Performance data is typical. Actual data may vary slightly from one production motor to another.

Les donnees sur les performances sont basees sur des tests utilisant de l'huile 10W40 d'une viscosite de 200 SUS a 54°C (130°F). Ces donnees correspondent a des situations typiques. Les donnees reelles peuvent varier legerement d'un moteur de production a l'autre.

Intermittierende Werte maximal 10% von jeder Betriebsminute.  
Capacidad de funcionamiento intermitente valida para 6 segundos por cada minuto.

Leistungsdaten sind gemessen mit SAE 10W40 bei einer Viskosität von 43,1 Cst bei 54°C. Geringfügige Abweichungen von den Katalogdaten sind möglich.

Datos tecnicos obtenidos con aceite 10W40 de 200 SUS de viscosidad a 54°C (130°F). Los datos proporcionados son valores tipicos. Los valores exactos reales podrian tener una pequena variacion entre distintos motores.

**Flange Mount / Standardgehäuse**  
**Monture à bride(s) / Montaje de brida**

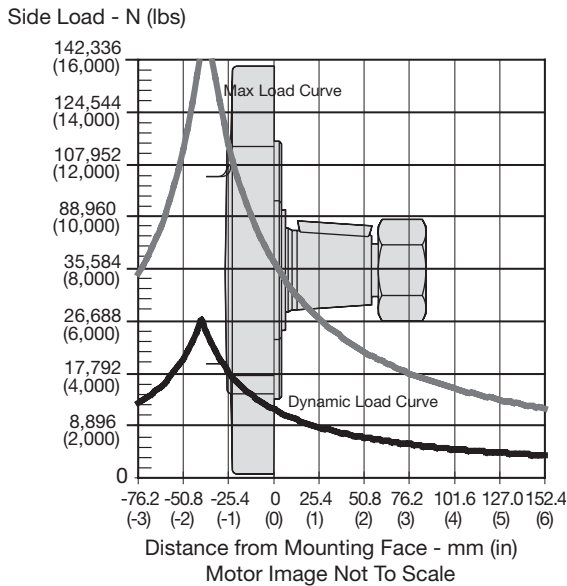

The dynamic side load curve is based on uni-directional steady state loads for  $L_{10}$  bearing life at  $3 \times 10^6$  revolutions. Die zulässige auslegbare radiale Wellenbelastungskurve ist unter ruhenden, einseitig statisch gerichteten Lastverhältnissen auf eine  $L_{10}$  Lebensdauer mit  $3 \times 10^6$  Umdrehungen kalkuliert. La courbe de charge latérale permise se base sur des charges unidirectionnelles en régime permanent pour le roulement  $L_{10}$  à  $3 \times 10^6$  révolutions. La curva de valores admisibles de carga lateral está basada en cargas constantes para cojinetes  $L_{10}$  a  $3 \times 10^6$  revoluciones.

**Wheel Mount / Radnabengehäuse**  
**Monture à roue / Montaje de rueda**

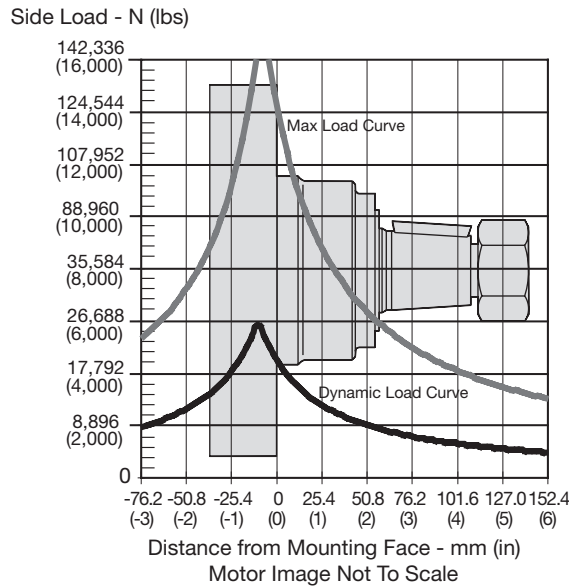

The maximum load curve is defined by bearing static load capacity. This curve should not be exceeded at any time including shock loads. Die maximale radiale Wellenbelastungskurve ist definiert als maximale statische Last ohne Drehzahl. Sie gilt als Grenze und sollte keinesfalls überschritten werden. La courbe de charge maximale est définie par la capacité de charge statique portante. Cette courbe ne devrait être dépassée en aucun moment y compris pour les charges par à-coups. La curva de carga máxima queda definida por la capacidad de carga estática del cojinete. No se deben superar los valores de esta curva, ni siquiera con cargas provisorias de impacto.

**Equation to Calculate the Expected Radial Bearing Life**  
**Gleichung zur Ermittlung der Lagerlebensdauer**

Equation to calculate the dynamic bearing life for a given load:  
 Bestimmung der erlaubten radialen Wellenbelastung mit vorgegebener Last

Use  $F_a$ ,  $F_b$  and  $S$  in equation to determine hours of  $L_{10}$  bearing life.  
 Die Lebensdauer in Stunden ergibt sich durch einsetzen von  $F_a$ ,  $F_b$ , und  $S$  in die nachstehende Formel.

$$L = \frac{3.0 \times 10^6}{60 \times S} \left\{ \frac{F_a}{F_b} \right\}^{3.33}$$

Where / Mit:

$S$  = Shaft Speed RPM / Abtriebswellendrehzahl in  $\text{min}^{-1}$

$L$  = Life In Hours / Lebensdauer in Stunden

$F_a$  = Allowable side load defined by above curve at a distance from mounting flange. / Erlaubte radiale Wellenbelastung als Funktion der Länge

$F_b$  = Application side load. / Anwendungsseitige Wellenbelastung

Note: Calculations are based on  $L_{10}$  bearing life per ISO 281.  
 Auslegung basiert auf einer  $L_{10}$  Lebensdauer nach ISO 281

**Code: AM**  
**SAE A 2-Bolt, Manifold**

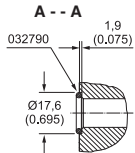
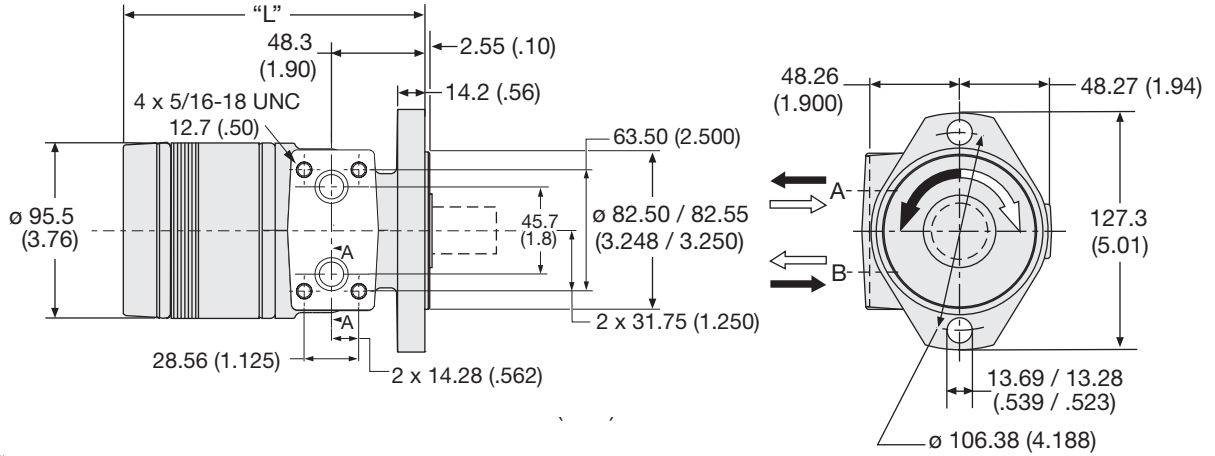

Motor with manifold mount is supplied with 2 O-rings.  
 Zum Motor mit Universalanschluß werden 2 O-Ringe geliefert.  
 Deux joints toriques sont livrés avec les moteurs a plan de raccordement universel.  
 Il blocchetto connessioni è corredato da 2 OR.

Code AM disp.	0036	0045	0050	0065	0080	0100	0130	0165	0195	0230	0260	0295	0330	0365	0390
Weight/Gewicht kg	5.87	6.03	6.12	6.26	6.35	6.49	6.76	7.03	7.35	7.58	7.80	8.07	8.35	8.66	8.80
Poids/Peso (lb)	(12.9)	(13.3)	(13.5)	(13.8)	(14.0)	(14.3)	(14.9)	(15.5)	(16.2)	(16.7)	(17.2)	(17.8)	(18.4)	(19.1)	(19.4)
Length "L" mm	132.6	136.1	137.7	140.7	144.0	147.1	153.4	159.8	166.1	172.5	178.8	185.1	191.5	200.2	202.2
"L" (in)	(5.22)	(5.36)	(5.42)	(5.54)	(5.67)	(5.79)	(6.04)	(6.29)	(6.54)	(6.79)	(7.04)	(7.29)	(7.54)	(7.88)	(8.04)

**Code: AP**  
**SAE A 2-Bolt, 1/2-14 NPTF Pipe**

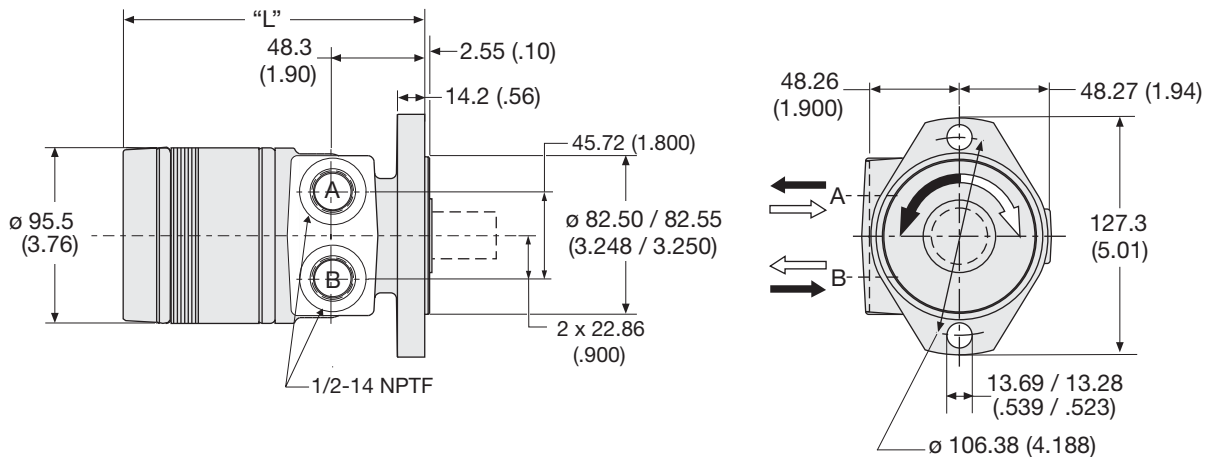

Code AP disp.	0036	0045	0050	0065	0080	0100	0130	0165	0195	0230	0260	0295	0330	0365	0390
Weight/Gewicht kg	5.87	6.03	6.12	6.26	6.35	6.49	6.76	7.03	7.35	7.58	7.80	8.07	8.35	8.66	8.80
Poids/Peso (lb)	(12.9)	(13.3)	(13.5)	(13.8)	(14.0)	(14.3)	(14.9)	(15.5)	(16.2)	(16.7)	(17.2)	(17.8)	(18.4)	(19.1)	(19.4)
Length "L" mm	132.6	136.1	137.7	140.7	144.0	147.1	153.4	159.8	166.1	172.5	178.8	185.1	191.5	200.2	202.2
"L" (in)	(5.22)	(5.36)	(5.42)	(5.54)	(5.67)	(5.79)	(6.04)	(6.29)	(6.54)	(6.79)	(7.04)	(7.29)	(7.54)	(7.88)	(8.04)

English equivalents for metric specifications are shown in ( ).

004 TE.indd, b



**WARNING**  
 This product can expose you to chemicals including lead and DEHP, which are known to the State of California to cause cancer, and birth defects or other reproductive harm. For more information go to [www.p65warnings.ca.gov](http://www.p65warnings.ca.gov)

**Parker Hannifin Corporation**  
 Pump & Motor Division  
 Greeneville, Tennessee, USA

**Code: AS**  
**SAE A 2-Bolt, 7/8-14 SAE O-Ring**

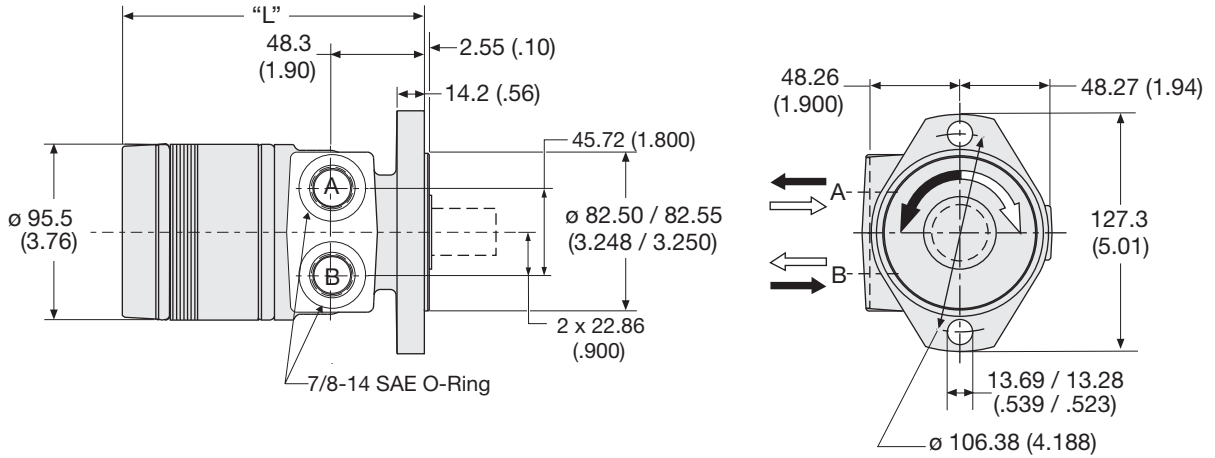

Code AS disp.	0036	0045	0050	0065	0080	0100	0130	0165	0195	0230	0260	0295	0330	0365	0390
Weight/Gewicht kg	5.87	6.03	6.12	6.26	6.35	6.49	6.76	7.03	7.35	7.58	7.80	8.07	8.35	8.66	8.80
Poids/Peso (lb)	(12.9)	(13.3)	(13.5)	(13.8)	(14.0)	(14.3)	(14.9)	(15.5)	(16.2)	(16.7)	(17.2)	(17.8)	(18.4)	(19.1)	(19.4)
Length "L" mm	132.6	136.1	137.7	140.7	144.0	147.1	153.4	159.8	166.1	172.5	178.8	185.1	191.5	200.2	202.2
"L" (in)	(5.22)	(5.36)	(5.42)	(5.54)	(5.67)	(5.79)	(6.04)	(6.29)	(6.54)	(6.79)	(7.04)	(7.29)	(7.54)	(7.88)	(8.04)

**Code: BS**  
**SAE B 2-Bolt**  
**7/8-14 SAE**

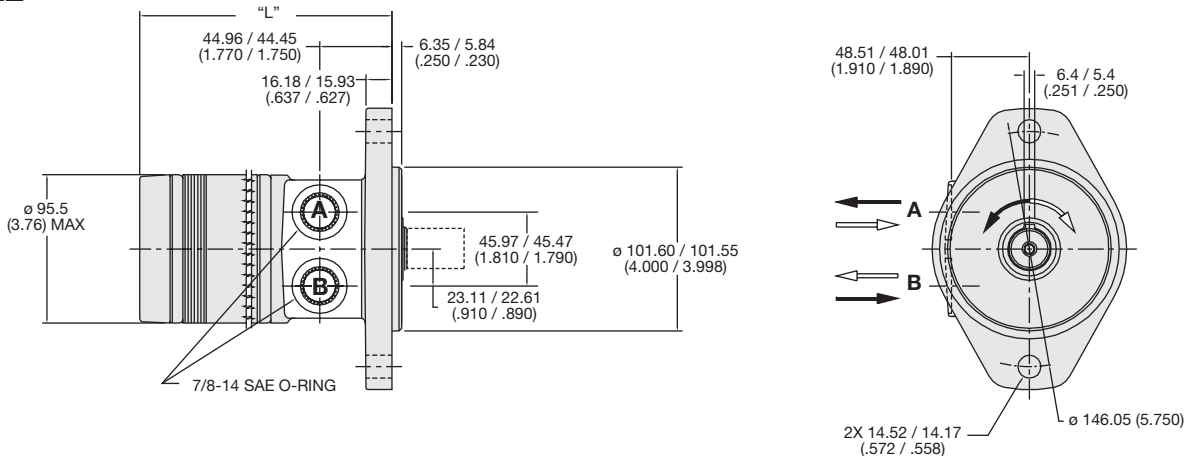

Code BS disp.	0036	0045	0050	0065	0080	0100	0130	0165	0195	0230	0260	0295	0330	0365	0390
Weight/Gewicht kg	7.27	7.34	7.48	7.62	7.71	7.84	8.11	8.39	8.70	8.93	9.16	9.43	9.70	9.97	10.1
Poids/Peso (lb)	(15.9)	(16.3)	(16.5)	(16.8)	(17.0)	(17.3)	(17.9)	(18.5)	(19.2)	(19.7)	(20.2)	(20.8)	(21.4)	(22.0)	(22.4)
Length "L" mm	131.5	132.5	134.1	137.1	140.4	143.5	149.8	156.2	162.5	168.9	175.2	181.6	187.9	196.5	200.9
"L" (in)	(5.18)	(5.22)	(5.28)	(5.40)	(5.53)	(5.65)	(5.90)	(6.15)	(6.40)	(6.65)	(6.90)	(7.15)	(7.40)	(7.74)	(7.91)

English equivalents for metric specifications are shown in ( ).

004 TE.indd, b



**WARNING**  
 This product can expose you to chemicals including lead and DEHP, which are known to the State of California to cause cancer, and birth defects or other reproductive harm. For more information go to [www.p65warnings.ca.gov](http://www.p65warnings.ca.gov)

**Parker Hannifin Corporation**  
 Pump & Motor Division  
 Greeneville, Tennessee, USA

**Code: FP**  
**Four Bolt, 1/2-14 NPTF Pipe**

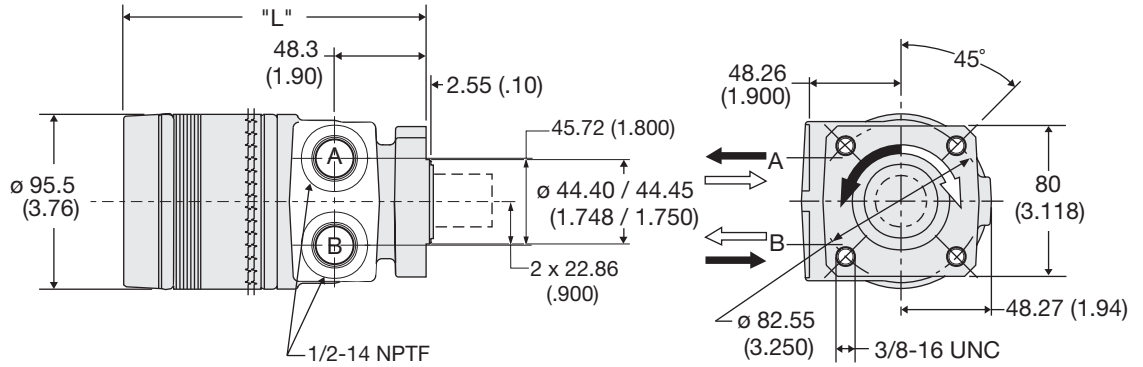

Code FP disp.	0036	0045	0050	0065	0080	0100	0130	0165	0195	0230	0260	0295	0330	0365	0390
Weight/Gewicht kg	5.58	5.62	5.67	5.80	5.94	6.08	6.31	6.62	7.03	7.17	7.39	7.62	7.94	8.26	8.39
Poids/Peso (lb)	(12.3)	(12.4)	(12.5)	(12.8)	(13.1)	(13.4)	(13.9)	(14.6)	(15.5)	(15.8)	(16.3)	(16.8)	(17.5)	(18.2)	(18.5)
Length "L" mm	132.6	136.1	137.7	140.7	144.0	147.1	153.4	159.8	166.1	172.5	178.8	185.1	191.5	200.2	202.2
"L" (in)	(5.22)	(5.36)	(5.42)	(5.54)	(5.67)	(5.79)	(6.04)	(6.29)	(6.54)	(6.79)	(7.04)	(7.29)	(7.54)	(7.88)	(8.04)

**Code: FS**  
**Four Bolt, 7/8-14 SAE O-Ring**

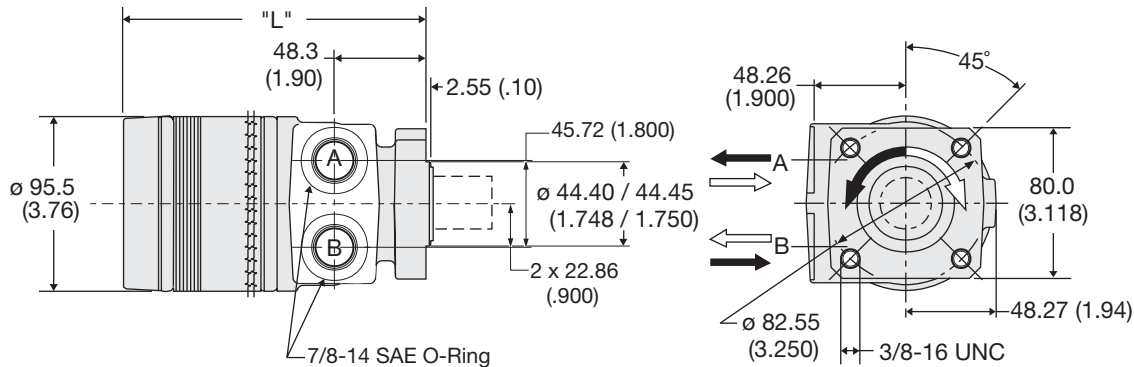

Code FS disp.	0036	0045	0050	0065	0080	0100	0130	0165	0195	0230	0260	0295	0330	0365	0390
Weight/Gewicht kg	5.58	5.62	5.67	5.80	5.94	6.08	6.31	6.62	7.03	7.17	7.39	7.62	7.94	8.26	8.39
Poids/Peso (lb)	(12.3)	(12.4)	(12.5)	(12.8)	(13.1)	(13.4)	(13.9)	(14.6)	(15.5)	(15.8)	(16.3)	(16.8)	(17.5)	(18.2)	(18.5)
Length "L" mm	132.6	136.1	137.7	140.7	144.0	147.1	153.4	159.8	166.1	172.5	178.8	185.1	191.5	200.2	202.2
"L" (in)	(5.22)	(5.36)	(5.42)	(5.54)	(5.67)	(5.79)	(6.04)	(6.29)	(6.54)	(6.79)	(7.04)	(7.29)	(7.54)	(7.88)	(8.04)

English equivalents for metric specifications are shown in ( ).

004 TE.indd, b



**WARNING**

This product can expose you to chemicals including lead and DEHP, which are known to the State of California to cause cancer, and birth defects or other reproductive harm. For more information go to [www.p65warnings.ca.gov](http://www.p65warnings.ca.gov)



**Code: CS**  
**SAE "A" 2-Bolt Long Pilot, 7/8-14 SAE O-Ring**

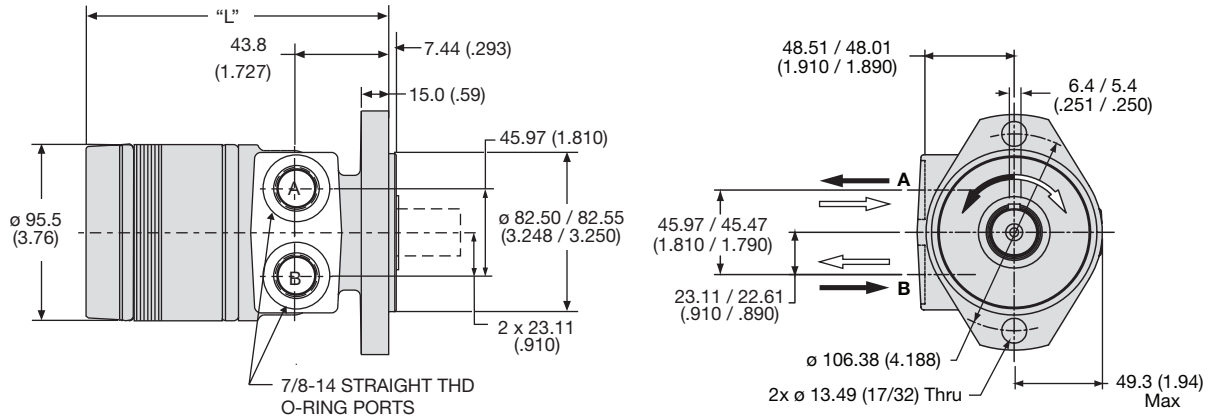

Code CS	disp.	0036	0045	0050	0065	0080	0100	0130	0165	0195	0230	0260	0295	0330	0365	0390
Weight/Gewichtkg		5.87	6.03	6.12	6.26	6.35	6.49	6.76	7.03	7.35	7.58	7.80	8.07	8.35	8.66	8.80
Poids/Peso	(lb)	(12.9)	(13.3)	(13.5)	(13.8)	(14.0)	(14.3)	(14.9)	(15.5)	(16.2)	(16.7)	(17.2)	(17.8)	(18.4)	(19.1)	(19.4)
Length	"L" mm	130.4	131.5	132.9	136.1	139.3	142.5	148.8	155.2	161.5	167.9	174.2	180.6	186.9	195.6	199.7
	"L" (in)	(5.13)	(5.18)	(5.23)	(5.36)	(5.48)	(5.61)	(5.86)	(6.11)	(6.36)	(6.61)	(6.86)	(7.11)	(7.36)	(7.70)	(7.86)

**Code: MS**  
**Magneto, 7/8-14 SAE O-Ring**

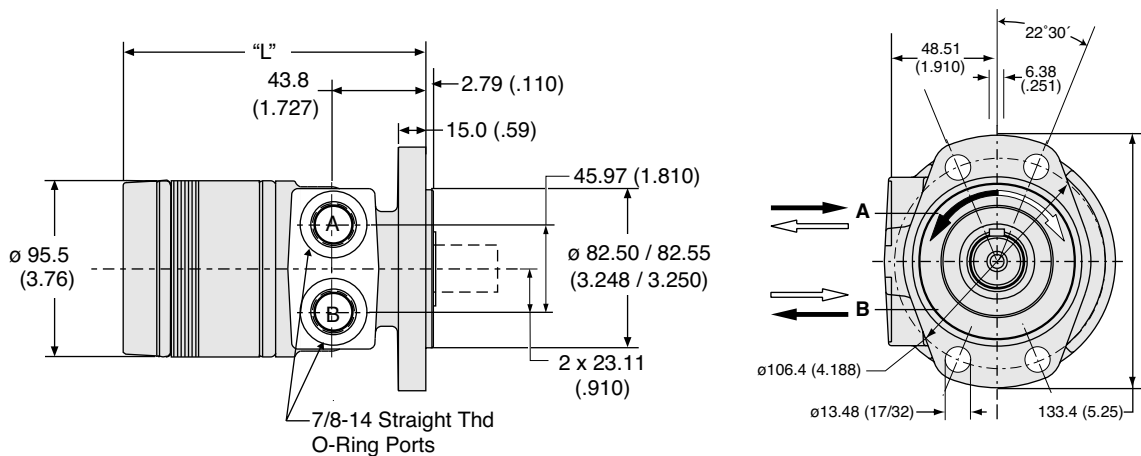

Code MS	disp.	0036	0045	0050	0065	0080	0100	0130	0165	0195	0230	0260	0295	0330	0365	0390
Weight/Gewicht	kg	6.16	6.30	6.40	6.53	6.62	6.76	7.03	7.30	7.62	7.85	8.12	8.35	8.62	8.94	9.07
Poids/Peso	(lb)	(13.6)	(13.9)	(14.1)	(14.4)	(14.6)	(14.9)	(15.5)	(16.1)	(16.8)	(17.3)	(17.9)	(18.4)	(19.0)	(19.7)	(20.0)
Length	"L" mm	135.1	136.1	137.6	140.8	144.0	147.1	153.5	159.8	166.2	172.5	178.9	185.2	191.6	200.2	204.3
	"L" (in)	(5.32)	(5.36)	(5.42)	(5.54)	(5.67)	(5.79)	(6.04)	(6.29)	(6.54)	(6.79)	(7.04)	(7.29)	(7.54)	(7.88)	(8.04)

English equivalents for metric specifications are shown in ( ).

004 TE.indd, b



**WARNING**  
This product can expose you to chemicals including lead and DEHP, which are known to the State of California to cause cancer, and birth defects or other reproductive harm. For more information go to [www.p65warnings.ca.gov](http://www.p65warnings.ca.gov)

Parker Hannifin Corporation  
Pump & Motor Division  
Greenville, Tennessee, USA

**Code: NS**  
**Midmount, 7/8-14 SAE O-Ring**

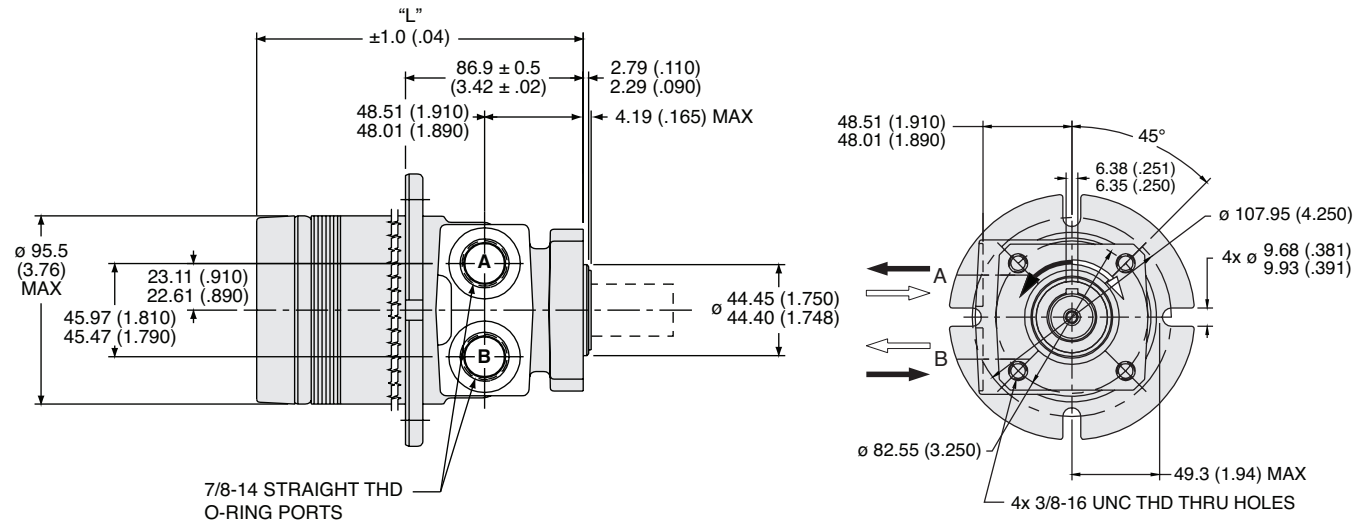

Code NS	disp.	0036	0045	0050	0065	0080	0100	0130	0165	0195	0230	0260	0295	0330	0365	0390
<b>Weight/Gewicht</b> kg	<b>5.58</b>	<b>5.62</b>	<b>5.67</b>	<b>5.80</b>	<b>5.94</b>	<b>6.08</b>	<b>6.31</b>	<b>6.62</b>	<b>7.03</b>	<b>7.17</b>	<b>7.39</b>	<b>7.62</b>	<b>7.94</b>	<b>8.26</b>	<b>8.39</b>	
Poids/Peso (lb)	(12.3)	(12.4)	(12.5)	(12.8)	(13.1)	(13.4)	(13.9)	(14.6)	(15.5)	(15.8)	(16.3)	(16.8)	(17.5)	(18.2)	(18.5)	
<b>Length</b> "L" mm	<b>132.6</b>	<b>136.1</b>	<b>137.6</b>	<b>140.8</b>	<b>144.0</b>	<b>147.1</b>	<b>153.5</b>	<b>159.8</b>	<b>166.2</b>	<b>172.5</b>	<b>178.9</b>	<b>185.2</b>	<b>191.6</b>	<b>200.2</b>	<b>204.3</b>	
"L" (in)	(5.22)	(5.36)	(5.42)	(5.54)	(5.67)	(5.79)	(6.04)	(6.29)	(6.54)	(6.79)	(7.04)	(7.29)	(7.54)	(7.88)	(8.04)	

**Code: LS**  
**Wheel Mount, 7/8-14 SAE O-Ring**

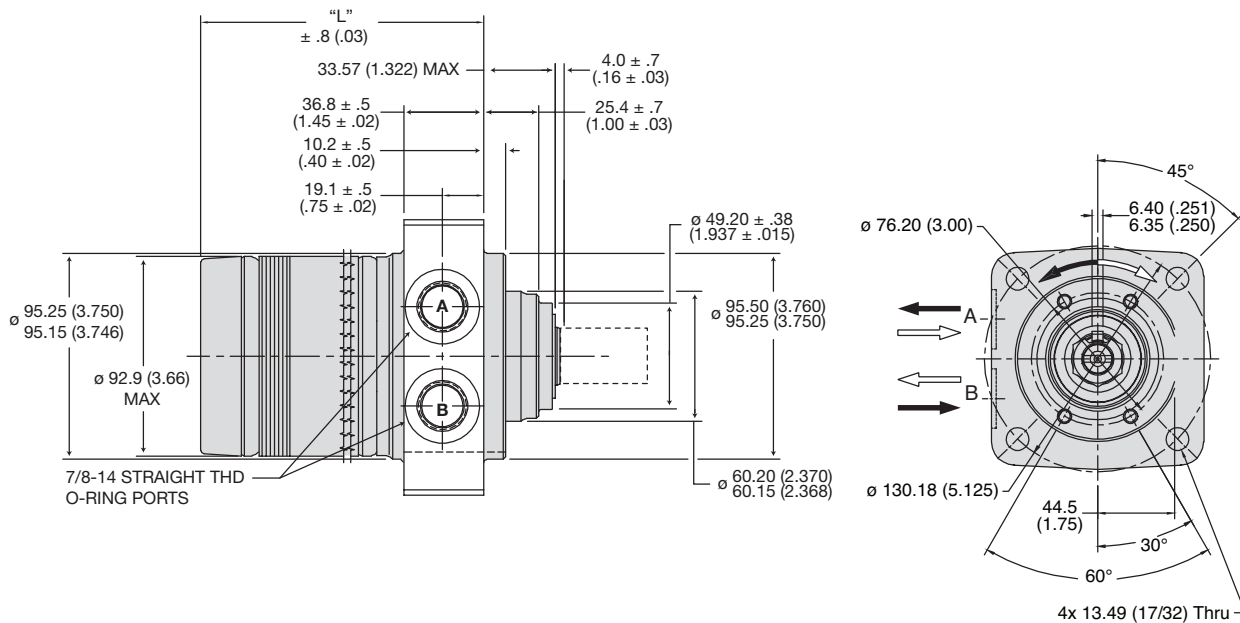

Code LS	disp.	0036	0045	0050	0065	0080	0100	0130	0165	0195	0230	0260	0295	0330	0365	0390
<b>Weight/Gewicht</b> kg	<b>6.67</b>	<b>6.80</b>	<b>6.90</b>	<b>7.00</b>	<b>7.10</b>	<b>7.20</b>	<b>7.60</b>	<b>7.80</b>	<b>8.10</b>	<b>8.30</b>	<b>8.60</b>	<b>8.80</b>	<b>9.10</b>	<b>9.40</b>	<b>9.60</b>	
Poids/Peso (lb)	(14.7)	(15.0)	(15.2)	(15.4)	(15.6)	(15.8)	(16.7)	(17.2)	(17.9)	(18.3)	(19.0)	(19.4)	(20.0)	(20.7)	(21.2)	
<b>Length</b> "L" mm	<b>105.8</b>	<b>106.9</b>	<b>108.5</b>	<b>111.5</b>	<b>114.7</b>	<b>117.9</b>	<b>124.3</b>	<b>130.6</b>	<b>137.0</b>	<b>143.3</b>	<b>149.7</b>	<b>156.0</b>	<b>162.4</b>	<b>171.0</b>	<b>175.1</b>	
"L" (in)	(4.17)	(4.21)	(4.27)	(4.39)	(4.52)	(4.64)	(4.89)	(5.14)	(5.39)	(5.64)	(5.89)	(6.14)	(6.39)	(6.73)	(6.89)	

English equivalents for metric specifications are shown in ( ).

004 TE.indd, b



**WARNING**  
 This product can expose you to chemicals including lead and DEHP, which are known to the State of California to cause cancer, and birth defects or other reproductive harm. For more information go to [www.p65warnings.ca.gov](http://www.p65warnings.ca.gov)

**Parker Hannifin Corporation**  
 Pump & Motor Division  
 Greeneville, Tennessee, USA

**Code: US**  
**Wheel Mount, 7/8-14 SAE O-Ring**

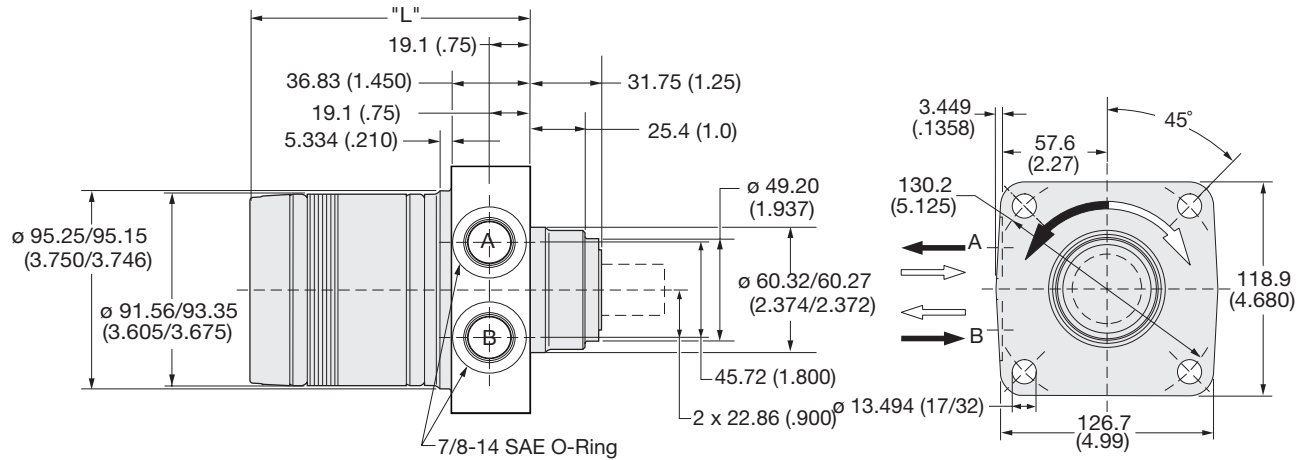

Code US	disp.	0036	0045	0050	0065	0080	0100	0130	0165	0195	0230	0260	0295	0330	0365	0390
<b>Weight/Gewicht</b>	<b>kg</b>	<b>6.67</b>	<b>6.80</b>	<b>6.90</b>	<b>7.00</b>	<b>7.10</b>	<b>7.20</b>	<b>7.60</b>	<b>7.80</b>	<b>8.10</b>	<b>8.30</b>	<b>8.60</b>	<b>8.80</b>	<b>9.10</b>	<b>9.40</b>	<b>9.60</b>
Poids/Peso	(lb)	(14.7)	(15.0)	(15.2)	(15.4)	(15.6)	(15.8)	(16.7)	(17.2)	(17.9)	(18.3)	(19.0)	(19.4)	(20.0)	(20.7)	(21.2)
<b>Length</b>	<b>"L" mm</b>	<b>105.8</b>	<b>106.9</b>	<b>108.5</b>	<b>111.5</b>	<b>114.7</b>	<b>117.9</b>	<b>124.3</b>	<b>130.6</b>	<b>137.0</b>	<b>143.3</b>	<b>149.7</b>	<b>156.0</b>	<b>162.4</b>	<b>171.0</b>	<b>175.1</b>
	"L" (in)	(4.17)	(4.21)	(4.27)	(4.39)	(4.52)	(4.64)	(4.89)	(5.14)	(5.39)	(5.64)	(5.89)	(6.14)	(6.39)	(6.73)	(6.89)

English equivalents for metric specifications are shown in ( ).

English equivalents for metric specifications are shown in ( ).

004 TE.indd, b



**WARNING**  
 This product can expose you to chemicals including lead and DEHP, which are known to the State of California to cause cancer, and birth defects or other reproductive harm. For more information go to [www.p65warnings.ca.gov](http://www.p65warnings.ca.gov)

**Parker Hannifin Corporation**  
 Pump & Motor Division  
 Greeneville, Tennessee, USA

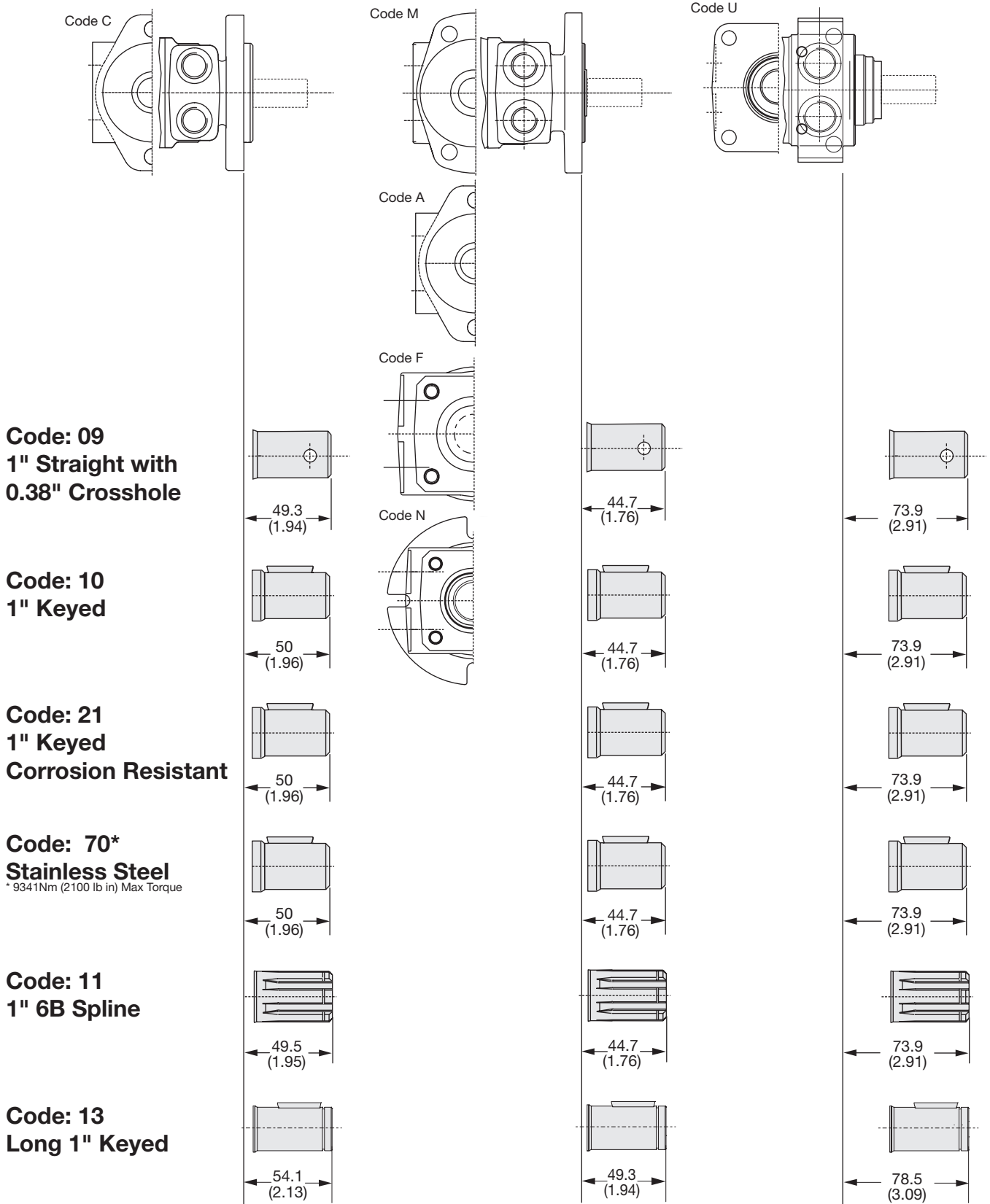

English equivalents for metric specifications are shown in ( ).

004 TE.indd, b



**WARNING**

This product can expose you to chemicals including lead and DEHP, which are known to the State of California to cause cancer, and birth defects or other reproductive harm. For more information go to [www.p65warnings.ca.gov](http://www.p65warnings.ca.gov)

**Parker Hannifin Corporation**  
 Pump & Motor Division  
 Greeneville, Tennessee, USA

Code L

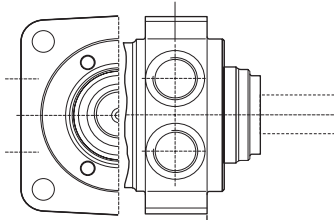

**Code: 09**  
**1" Straight with**  
**0.38" Crosshole**

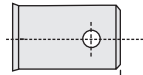

74.8  
(2.94)

**Code: 10**  
**1" Keyed**

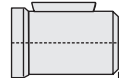

75.5  
(2.97)

**Code: 21**  
**1" Keyed**  
**Corrosion Resistant**

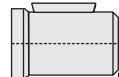

75.5  
(2.97)

**Code: 70\***  
**1" Keyed, 1/4" Tap,**  
**Stainless Steel**

\* 9341Nm (2100 lb in) Max Torque

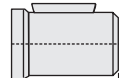

75.5  
(2.97)

**Code: 11**  
**1" 6B Spline**

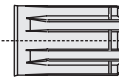

75.0  
(2.95)

**Code: 13**  
**Long 1" Keyed**

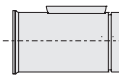

79.6  
(3.13)

English equivalents for metric specifications are shown in ( ).

004 TE.indd, b



**WARNING**

This product can expose you to chemicals including lead and DEHP, which are known to the State of California to cause cancer, and birth defects or other reproductive harm. For more information go to [www.p65warnings.ca.gov](http://www.p65warnings.ca.gov)

**Code: 09**  
**1" Straight with**  
**0.38" Crosshole**



**Code: 10**  
**1" Keyed**

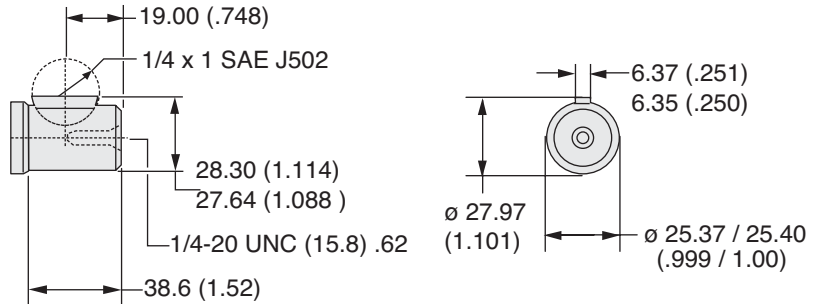

**Code: 21**  
**1" Keyed**  
**Corrosion Resistant**

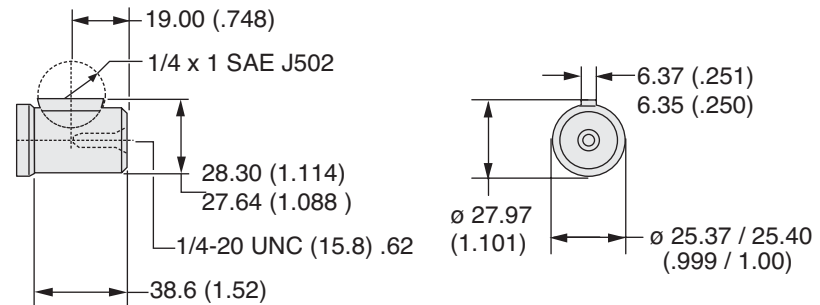

**Code: 70\***  
**1" Keyed, 1/4" Tap,**  
**Stainless Steel**

\* 9341Nm (2100 lb in) Max Torque

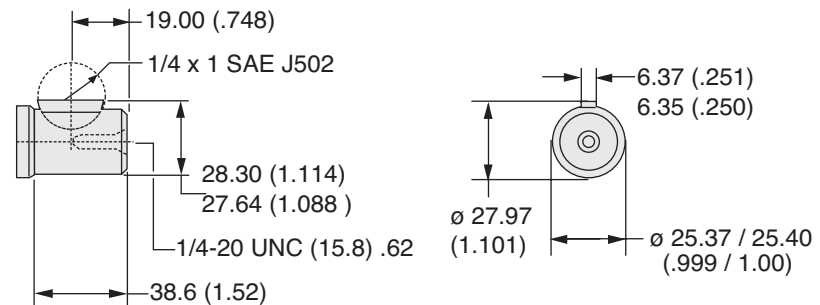

English equivalents for metric specifications are shown in ( ).

004 TE.indd, b



**WARNING**  
This product can expose you to chemicals including lead and DEHP, which are known to the State of California to cause cancer, and birth defects or other reproductive harm. For more information go to [www.p65warnings.ca.gov](http://www.p65warnings.ca.gov)

**Parker Hannifin Corporation**  
Pump & Motor Division  
Greeneville, Tennessee, USA

**Code: 11**  
**1" 6B Spline**

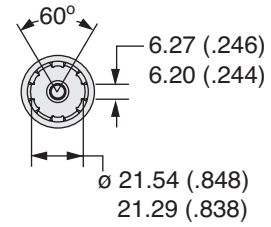
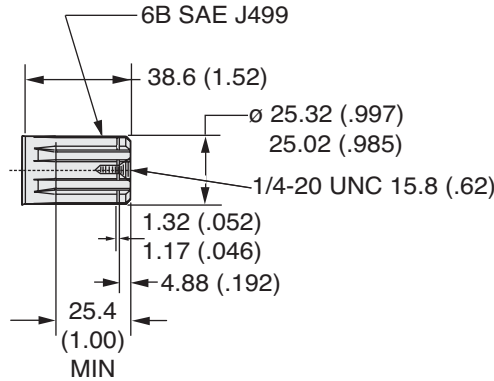

**Code: 13**  
**Long 1" Keyed**

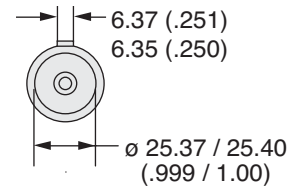
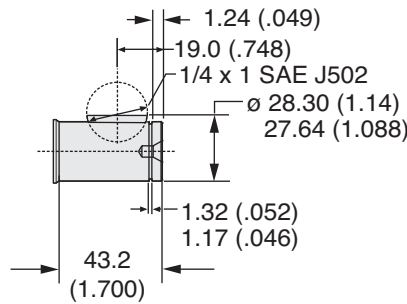

English equivalents for metric specifications are shown in ( ).

004 TE.indd, b



**WARNING**

This product can expose you to chemicals including lead and DEHP, which are known to the State of California to cause cancer, and birth defects or other reproductive harm. For more information go to [www.p65warnings.ca.gov](http://www.p65warnings.ca.gov)

**Parker Hannifin Corporation**  
 Pump & Motor Division  
 Greeneville, Tennessee, USA

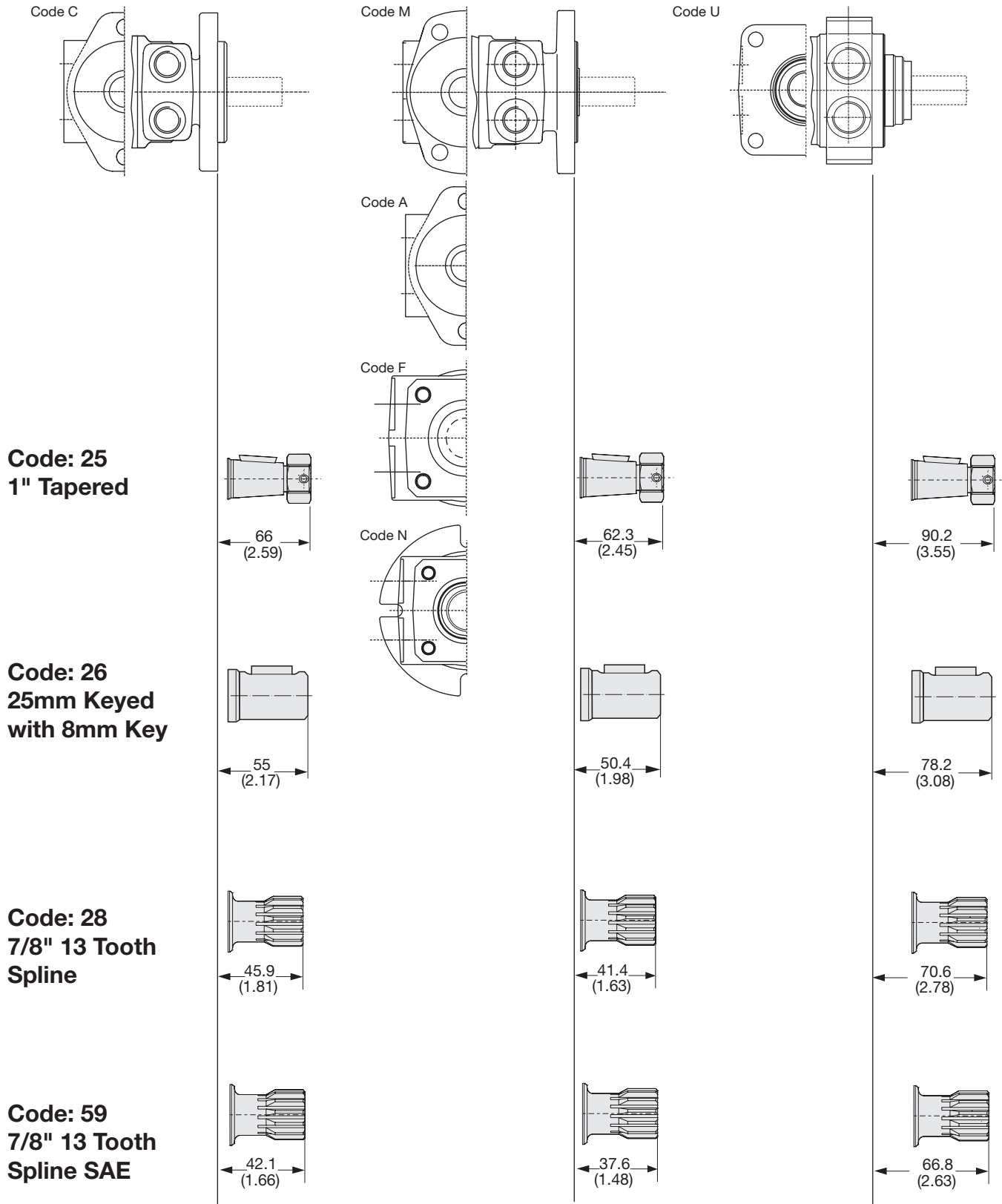

English equivalents for metric specifications are shown in ( ).

004 TE.indd, b



**WARNING**

This product can expose you to chemicals including lead and DEHP, which are known to the State of California to cause cancer, and birth defects or other reproductive harm. For more information go to [www.p65warnings.ca.gov](http://www.p65warnings.ca.gov)



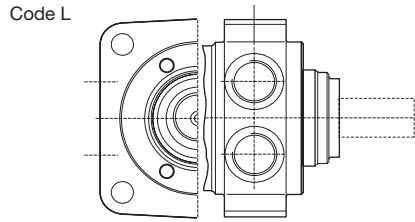

**Code: 25**  
**1" Tapered**

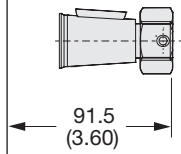

**Code: 26**  
**25mm Keyed**  
**with 8mm Key**

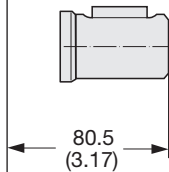

**Code: 28**  
**7/8" 13 Tooth**  
**Spline**

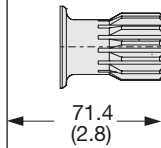

**Code: 59**  
**7/8" 13 Tooth**  
**Spline SAE**

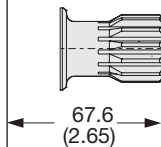

English equivalents for metric specifications are shown in ( ).

004 TE.indd, b



**WARNING**

This product can expose you to chemicals including lead and DEHP, which are known to the State of California to cause cancer, and birth defects or other reproductive harm. For more information go to [www.p65warnings.ca.gov](http://www.p65warnings.ca.gov)

**Code: 25**  
**1" Tapered**

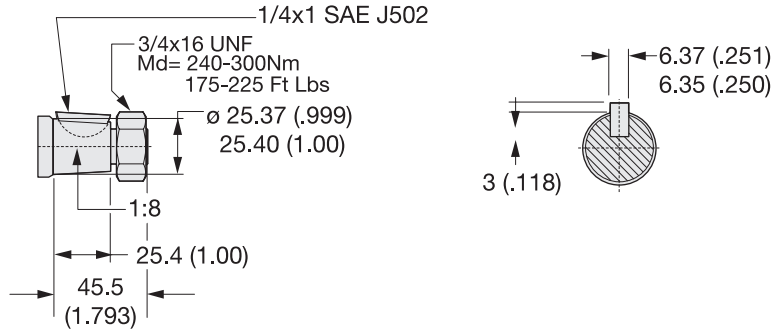

**Code: 26**  
**25mm Keyed**  
**with 8mm Key**

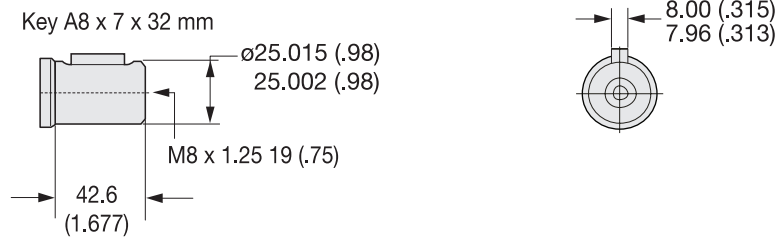

**Code: 28**  
**7/8" 13 Tooth**  
**Spline**



**Code: 59**  
**7/8" 13 Tooth**  
**Spline SAE**



**Code: 66**  
**25mm Keyed with**  
**8mm Key, Corrosion**  
**Resistant**

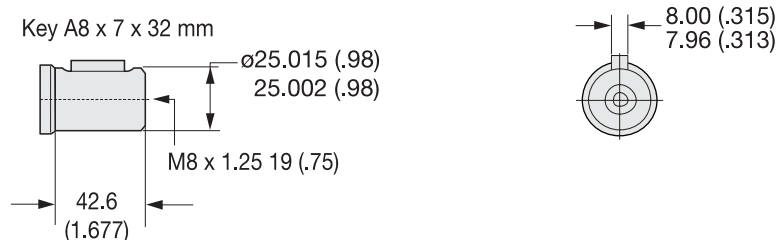

English equivalents for metric specifications are shown in ( ).

004 TE.indd, b



**WARNING**  
This product can expose you to chemicals including lead and DEHP, which are known to the State of California to cause cancer, and birth defects or other reproductive harm. For more information go to [www.p65warnings.ca.gov](http://www.p65warnings.ca.gov)

**Parker Hannifin Corporation**  
Pump & Motor Division  
Greeneville, Tennessee, USA

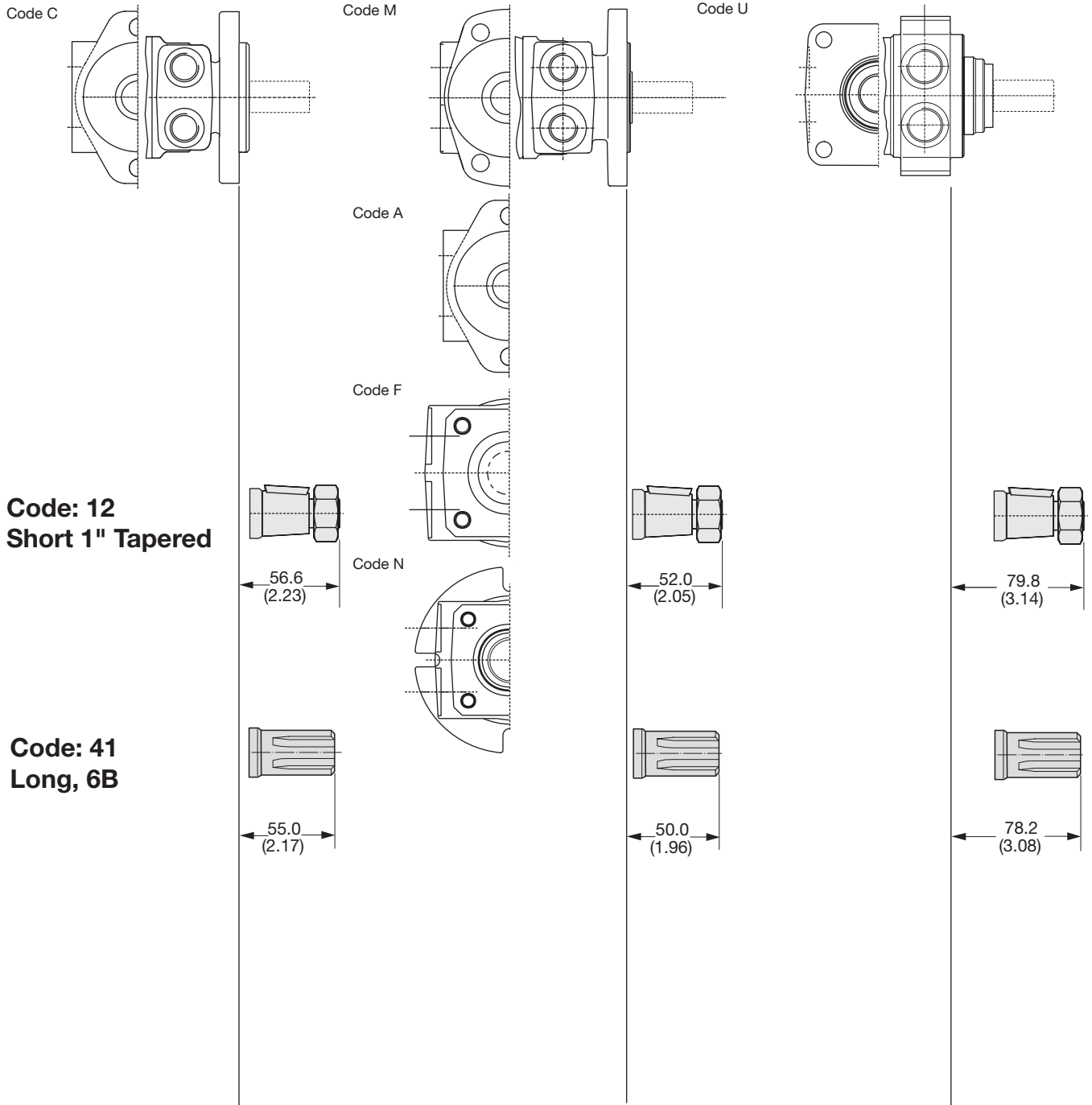

English equivalents for metric specifications are shown in ( ).

004 TE.indd, b



**WARNING**

This product can expose you to chemicals including lead and DEHP, which are known to the State of California to cause cancer, and birth defects or other reproductive harm. For more information go to [www.p65warnings.ca.gov](http://www.p65warnings.ca.gov)

Code L

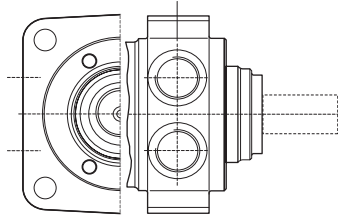

**Code: 12**  
**Short 1" Tapered**

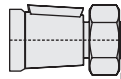

82.1  
(3.23)

**Code: 41**  
**Long, 6B**

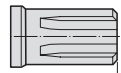

80.5  
(3.17)

English equivalents for metric specifications are shown in ( ).

004 TE.indd, b



**WARNING**

This product can expose you to chemicals including lead and DEHP, which are known to the State of California to cause cancer, and birth defects or other reproductive harm. For more information go to [www.p65warnings.ca.gov](http://www.p65warnings.ca.gov)

**Code: 12**  
**Short 1" Tapered**

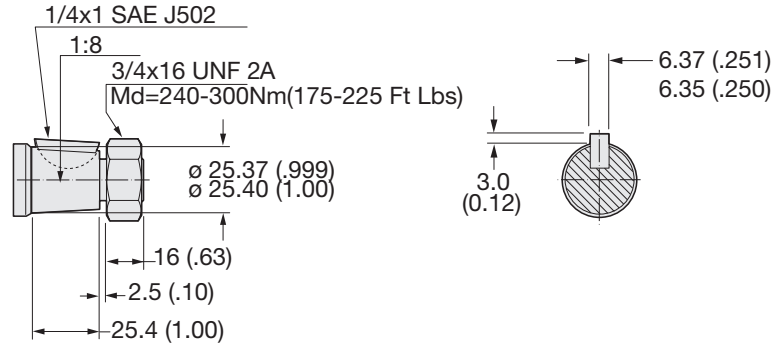

**Code: 41**  
**Long, 6B**



English equivalents for metric specifications are shown in ( ).

004 TE.indd, b



**WARNING**

This product can expose you to chemicals including lead and DEHP, which are known to the State of California to cause cancer, and birth defects or other reproductive harm. For more information go to [www.p65warnings.ca.gov](http://www.p65warnings.ca.gov)

**Parker Hannifin Corporation**  
Pump & Motor Division  
Greeneville, Tennessee, USA



 **WARNING**

This product can expose you to chemicals including lead and DEHP, which are known to the State of California to cause cancer, and birth defects or other reproductive harm. For more information go to [www.p65warnings.ca.gov](http://www.p65warnings.ca.gov)